

### A Wide Range of Models:

**6 × 6 mm, 12 × 12 mm, Side-operated, High-force, and Gold-plated.**

- Extended mechanical/electrical durability: 10 x 10<sup>6</sup> operations for 12 x 12 mm type and 1 x 10<sup>6</sup> operations for the 6 x 6 mm type
- Taped radial type, vertical type and high force types are available.
- Gold plated models available for increased contact reliability, resistance to corrosive gas and insulation failure prevention for ion migration in harsh environments
- Type B32 Key Tops are available for projected plunger models.

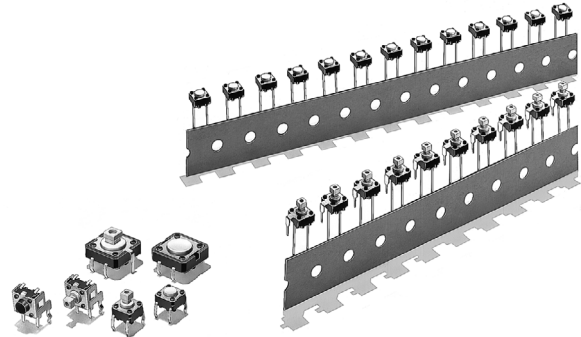



RoHS Compliant

### ■ List of Models

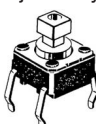
#### 6 × 6 mm Models

Type	Plunger	Height	Operating force (OF)	Plunger color	Bags (in units of 100 Switches)	
					Without ground terminal	With ground terminal
Standard (B3F-1000)	Flat type 	4.3 mm	0.98 N {100 gf}	Ivory	B3F-1000	B3F-1100
			1.47 N {150 gf}	Yellow	B3F-1002	B3F-1102
			2.55 N {260 gf}	Orange	B3F-1005	B3F-1105
			4.9 N {500 gf}	Red	B3F-1006	---
		5.0 mm	0.98 N {100 gf}	Black	B3F-1020	B3F-1120
			1.47 N {150 gf}	Gray	B3F-1022	B3F-1122
			2.55 N {260 gf}	Pink	B3F-1025	B3F-1125
			4.9 N {500 gf}	Blue	B3F-1026	---
		5.0 mm (7.5-mm pitch)	0.98 N {100 gf}	Black	---	B3F-1110
		7.0 mm	0.98 N {100 gf}	Black	B3F-1060	---
			1.47 N {150 gf}	Yellow	B3F-1062	---
			2.55 N {260 gf}	Orange	B3F-1075	---
	9.5 mm	0.98 N {100 gf}	Black	B3F-1070	---	
		1.47 N {150 gf}	Yellow	B3F-1072	---	
		2.55 N {260 gf}	Orange	B3F-1075	---	
	Projected type 	7.3 mm	0.98 N {100 gf}	Ivory	B3F-1050	B3F-1150
1.47 N {150 gf}			Yellow	B3F-1052	B3F-1152	
2.55 N {260 gf}			Orange	B3F-1055	B3F-1155	
4.9 N {500 gf}			Red	B3F-1056	---	

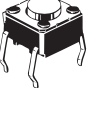
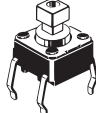
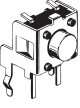
Type	Plunger	Height	Operating force (OF)	Plunger color	Bags (in units of 100 Switches)	
					Without ground terminal	With ground terminal
Side-operated (B3F-3000)	 Flat type	3.15 mm	0.98 N {100 gf}	Ivory	---	B3F-3100
			1.47 N {150 gf}	Yellow	---	B3F-3102
			2.55 N {260 gf}	Orange	---	B3F-3105
		3.85 mm	0.98 N {100 gf}	Black	---	B3F-3120
			1.47 N {150 gf}	Gray	---	B3F-3122
			2.55 N {260 gf}	Pink	---	B3F-3125
	 Projected type	6.15 mm	0.98 N {100 gf}	Ivory	---	B3F-3150
			1.47 N {150 gf}	Yellow	---	B3F-3152
			2.55 N {260 gf}	Orange	---	B3F-3155
High reliability gold-plated contact	 Flat type	4.3 mm	1.76 N {180 gf}	Yellow	B3F-1002-G	B3F-1102-G
		5.0 mm		Gray	B3F-1022-G	B3F-1122-G
		7.0 mm		Yellow	B3F-1062-G (see note)	---
		9.5 mm		Yellow	B3F-1072-G (see note)	---
	 Projected type	7.3 mm	Yellow	B3F-1052-G	---	
	 Flat type	3.85 mm	Gray	---	B3F-3122-G (see note)	

**Note:** Bulk Packaged, 100 Switches per bag. Order in multiples of the package quantity.

### 12 × 12 mm Models

Type	Plunger (or LED color)	Height	Operating force (OF)	Plunger color	Bags (in units of 100 Switches)	
					Without ground terminal	With ground terminal
Standard (B3F-4000)	Flat type	4.3 mm	1.27 N {130 gf}	Ivory	B3F-4000	B3F-4100
			2.55 N {260 gf}	Yellow	B3F-4005	B3F-4105
	Projected type	7.3 mm	1.27 N {130 gf}	Ivory	B3F-4050	B3F-4150
			2.55 N {260 gf}	Yellow	B3F-4055	B3F-4155
Long durability (B3F-5000)	Flat type	4.3 mm	1.27 N {130 gf}	Blue	B3F-5000	B3F-5100
	Projected type	7.3 mm		Blue	B3F-5050	B3F-5150
High reliability gold-plated (B3F-5001)	Flat type	4.3 mm	1.27 N {130 gf}	Blue	B3F-5001	B3F-5101
	Projected type	7.3 mm		Blue	B3F-5051	B3F-5151

**Note:** Bulk Packaged, 100 switches per bag. Order in multiples of the package quantity.

### 6 × 6 mm Radial Models (Taping Specifications)

Type	Plunger	Height	Operating force (OF)	Plunger color	Taped Radial (1000 Switches)	
					Without ground terminal	With ground terminal
Taped Radial (B3F-6000)	Flat type	4.3 mm	0.98 N {100 gf}	Ivory	B3F-6000	B3F-6100
			1.47 N {150 gf}	Yellow	B3F-6002	B3F-6102
		5.0 mm	0.98 N {100 gf}	Black	B3F-6020	B3F-6120
			1.47 N {150 gf}	Gray	B3F-6022	B3F-6122
	Projected type	7.3 mm	0.98 N {100 gf}	Ivory	B3F-6050	B3F-6150
			1.47 N {150 gf}	Yellow	B3F-6052	B3F-6152

**Note:** The switches are tape packaged in units of 1,000 per package. Order in multiples of the package size. Switches are not sold individually.

## ■ Ratings/Characteristics

<b>Ratings</b>	1 to 50 mA, 5 to 24 VDC (resistive load) (B3F-G: 100 $\mu$ A to 50 mA, 5 to 24 VDC)
<b>Ambient operating temperature</b>	-25°C to +70°C at 60%RH max. (with no icing or condensation)
<b>Ambient operating humidity</b>	35% to 85% (at +5 to +35°C)
<b>Contact form</b>	SPST-NO
<b>Contact resistance</b>	100 m $\Omega$ max. (initial value) (rated: 1 mA, 5 VDC) B3F-G: (rated: 100 $\mu$ A, 5 VDC)
<b>Insulation resistance</b>	100 M $\Omega$ min. (at 250 VDC)
<b>Dielectric strength</b>	500 VAC, 50/60 Hz for 1 min
<b>Bounce time</b>	5 ms max.
<b>Vibration resistance</b>	Malfunction: 10 to 55 Hz, 1.5 mm double amplitude
<b>Shock resistance</b>	Destruction: 1,000 m/s <sup>2</sup> {approx. 100G} max. Malfunction: 100 m/s <sup>2</sup> {approx. 10G} max.
<b>Durability</b>	B3F-1000, B3F-3000, B3F-6000: 1,000,000 operations min (OF: 0.98 N {100 gf}) (B3F-1070: 500,000 operations min) 300,000 operations min (OF: 1.47 N {150 gf}) 100,000 operations min (OF: 2.55 N {260 gf}) 50,000 operations min (OF: 4.9 N {500 gf})  B3F-4000: 3,000,000 operations min (OF: 1.27 N {131 gf}) 1,000,000 operations min (OF: 2.55 N {260 gf})  B3F-5000: 10,000,000 operations min.  B3F-G: 300,000 operations min.
<b>Weight</b>	6 $\times$ 6 mm models: approx. 0.25 g 12 $\times$ 12 mm models (standard types): approx. 0.85 g Radial models: approx. 0.25 g

## ■ Operating Characteristics

Operating force (OF)	B3F-1000, B3F-3000, B3F-6000				B3F-4000, B3F-5000		B3F-G
	0.98 N	1.47 N	2.55 N	4.9 N	1.27 N	2.55 N	1.76 N
Item	B3F-1□□0 B3F-3□□0 B3F-6□□0	B3F-1□□2 B3F-3□□2 B3F-6□□2	B3F-1□□5 B3F-3□□5	B3F-10□6	B3F-4□□0 B3F-5□□0 B3F-5□□1	B3F-4□□5	B3F-1□□2-G B3F-3□□2-G
<b>Operating force (OF)</b>	0.98 $\pm$ 0.29 N {100 $\pm$ 30 gf}	1.47 $\pm$ 0.49 N {150 $\pm$ 50 gf}	2.55 $\pm$ 0.69 N {260 $\pm$ 70 gf}	4.9 $\pm$ 1.47 N {500 $\pm$ 150 gf}	1.27 $\pm$ 0.49 N {130 $\pm$ 50 gf}	2.55 $\pm$ 0.69 N {260 $\pm$ 70 gf}	1.76 $\pm$ 0.49 N {180 $\pm$ 50 gf}
<b>Releasing force (RF)</b>	0.2 N {20 gf} min.	0.49 N {50 gf} min.	0.49 N {50 gf} min.	0.7 N {70 gf} min.	0.29 N {30 gf} min.	0.49 N {50 gf} min.	0.49 N {50 gf} min.
<b>Pretravel (PT)</b>	0.25 <sup>+0.2</sup> / <sub>-0.1</sub> mm				0.3 <sup>+0.2</sup> / <sub>-0.1</sub> mm		0.25 <sup>+0.2</sup> / <sub>-0.1</sub> mm

■ Dimensions (Unit: mm)

**Note:** The numbers used for terminals in the following graphics are indicated in the "Bottom View" diagram below. In this diagram, the Switch is rotated so that the terminals are on the right and left-hand sides, and the OMRON logo appears the right way up. (Except Side-operated and Radial Models)



6 × 6 mm Models

Standard, Flat Plunger Type  
(without Ground Terminal)

B3F-1000, B3F-1002, B3F-1005, B3F-1006  
B3F-1020 (See note.), B3F-1022 (See note.),  
B3F-1025 (See note.), B3F-1026 (See note.)  
B3F-1002-G, B3F-1022-G (See note.)

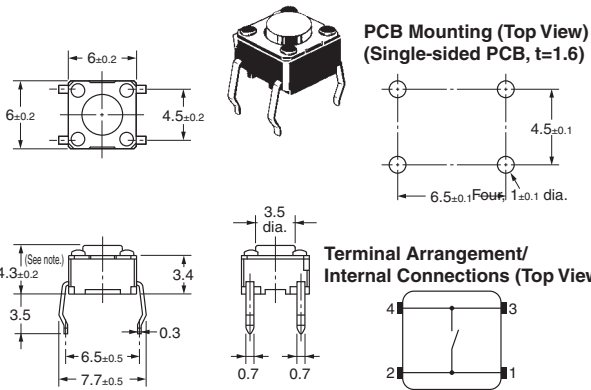

**Note:** The height of B3F-1020, B3F-1022, B3F-1025, and B3F-1026 is 5±0.2 mm.

Standard, Flat Plunger Type  
(with Ground Terminal, Pitch: 6.5 mm)

B3F-1100, B3F-1102, B3F-1105  
B3F-1120 (See note.), B3F-1122 (See note.)  
B3F-1125 (See note.)  
B3F-1102-G, B3F-1122-G (See note.)

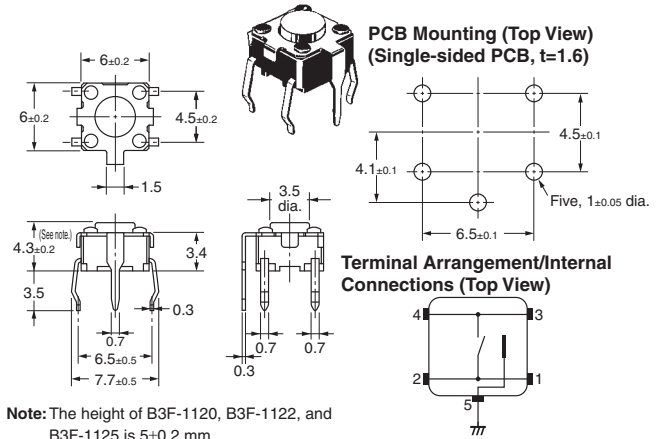

**Note:** The height of B3F-1120, B3F-1122, and B3F-1125 is 5±0.2 mm.

Standard, Flat Plunger Type  
(with Ground Terminal, Pitch: 7.5 mm)

B3F-1110

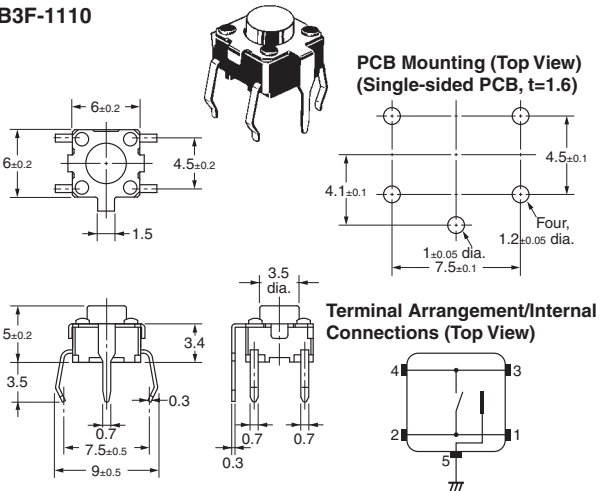

Standard, Flat Plunger Type  
(without Ground Terminal)

B3F-1060, B3F-1062, B3F-1062-G

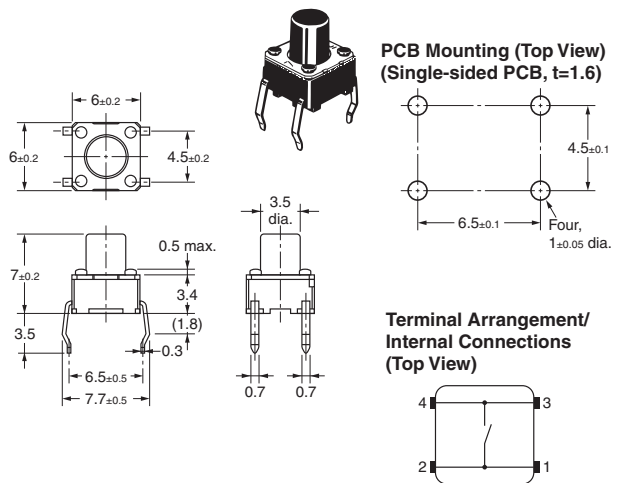

**Note:** Unless otherwise specified, a tolerance of ±0.4 mm applies to all dimensions. No terminal numbers are indicated on the Switches.

**Standard, Flat Plunger Type  
(without Ground Terminal)**

**B3F-1070, B3F-1072, B3F-1075, B3F-1072-G**

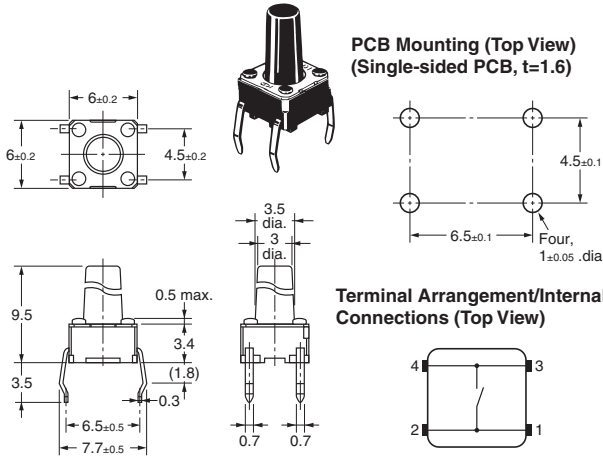

**Standard, Projected Plunger Type  
(without Ground Terminal)**

**B3F-1050, B3F-1052  
B3F-1055, B3F-1056  
B3F-1052-G**

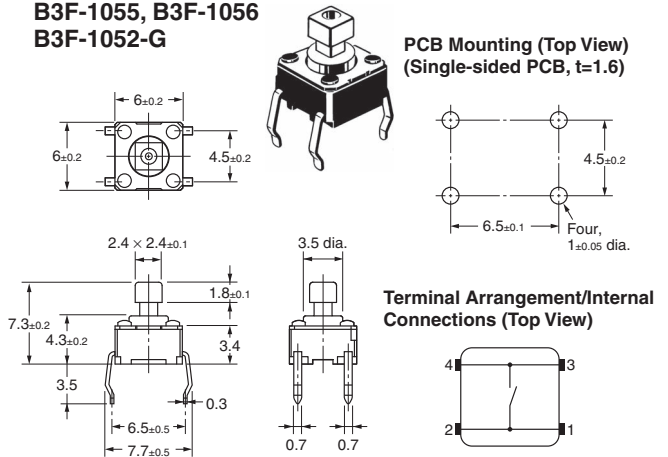

**Standard, Projected Plunger Type  
(with Ground Terminal)**

**B3F-1150, B3F-1152, B3F-1155**

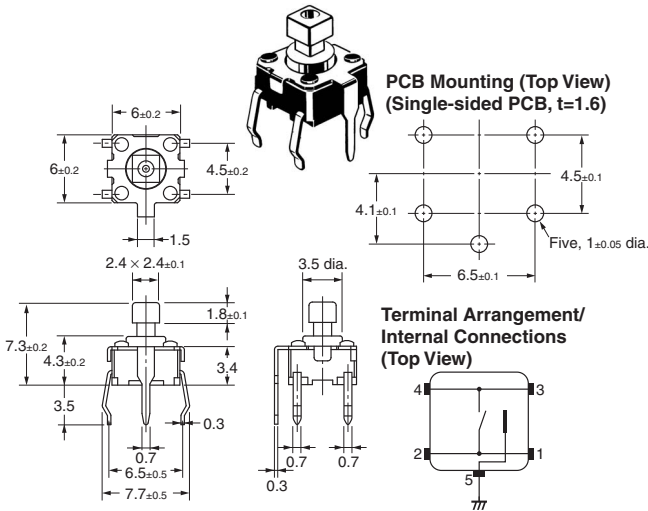

**Side-operated, Flat Plunger Type**

**B3F-3100, B3F-3102, B3F-3105**

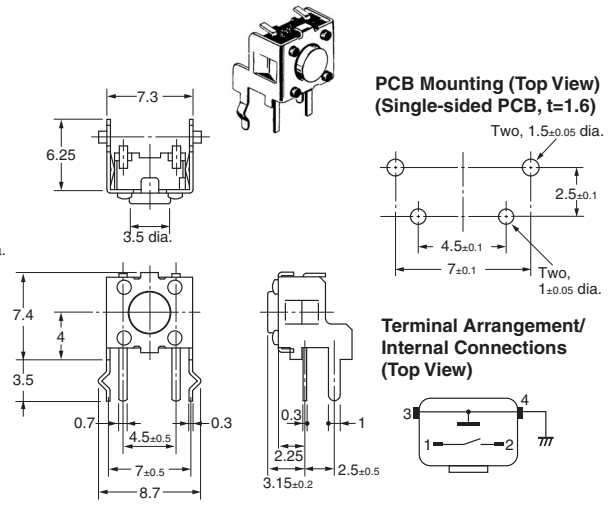

**Side-operated, Flat Plunger Type (Height: 3.85 mm)**

**B3F-3120, B3F-3122, B3F-3125, B3F-3122-G**

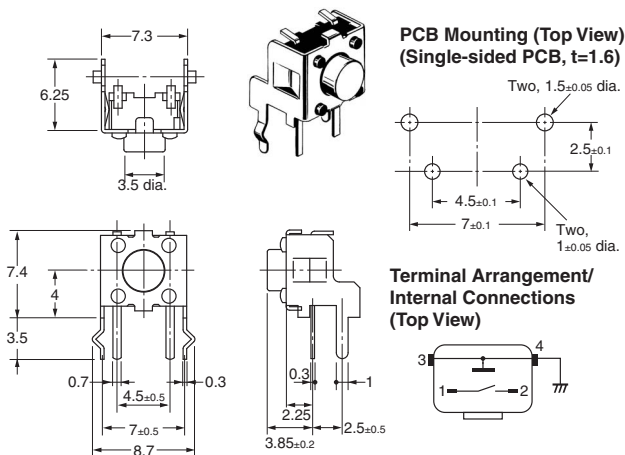

**Side-operated, Projected Plunger Type**

**B3F-3150, B3F-3152, B3F-3155**

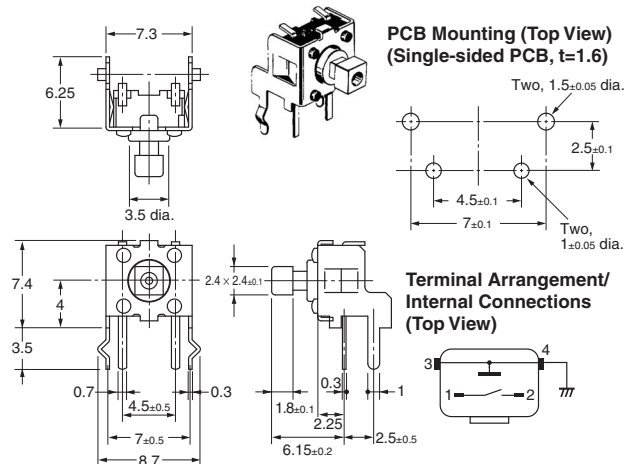

**Note:** Unless otherwise specified, a tolerance of ±0.4 mm applies to all dimensions. No terminal numbers are indicated on the Switches.

12 × 12 mm Models

Standard, Long-durability, and High-reliability Models  
Flat Plunger Type  
(without Ground Terminal)

B3F-4000, B3F-4005,  
B3F-5000, B3F-5001

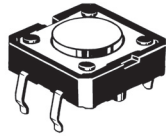

PCB Mounting (Top View)  
(Single-sided PCB, t=1.6)

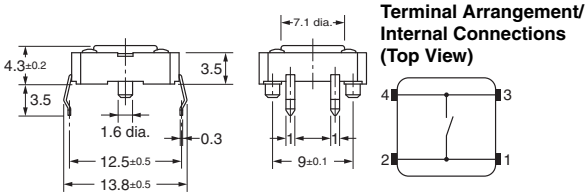
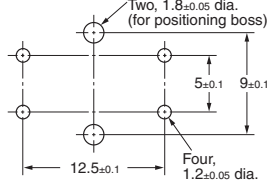
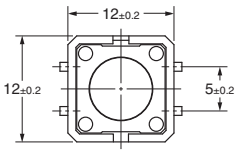

Standard, Long-durability, and High-reliability Models  
Flat Plunger Type  
(with Ground Terminal)

B3F-4100, B3F-4105,  
B3F-5100, B3F-5101

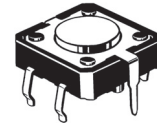

PCB Mounting (Top View)  
(Single-sided PCB, t=1.6)

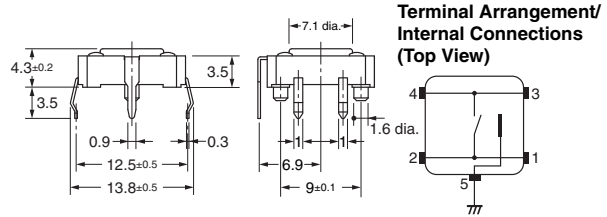
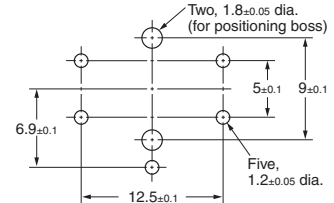
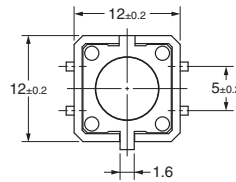

Standard, Long-durability, and High-reliability Models  
Projected Plunger Type  
(without Ground Terminal)

B3F-4050, B3F-4055,  
B3F-5050, B3F-5051

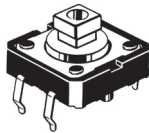

PCB Mounting (Top View)  
(Single-sided PCB, t=1.6)

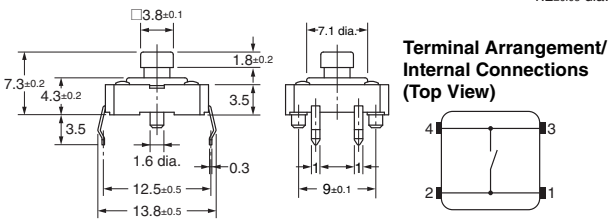
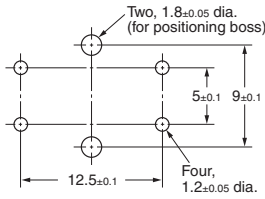
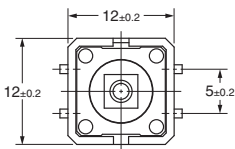

Standard, Long-durability, and High-reliability Models  
Projected Plunger Type  
(with Ground Terminal)

B3F-4150, B3F-4155,  
B3F-5150, B3F-5151

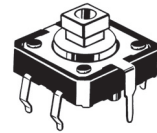

PCB Mounting (Top View)  
(Single-sided PCB, t=1.6)

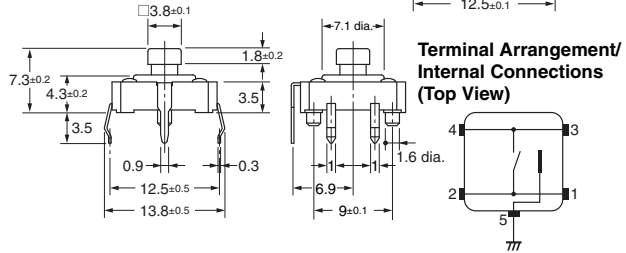
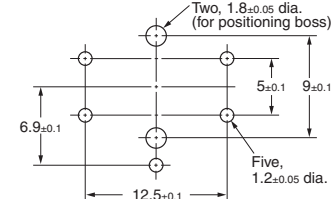
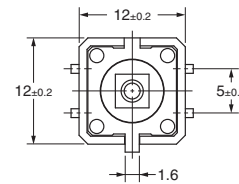

Note: Unless otherwise specified, a tolerance of ±0.4 mm applies to all dimensions.

**Note:** The numbers used for terminals in the following graphics are indicated in the "Bottom View" diagram below. In this diagram, the Switch is rotated so that the terminals are on the right and left-hand sides, and the OMRON logo appears the right way up.

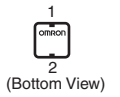

**6 mm × 6 mm Radial Types (Taping Specifications): Sold in Units of 1,000 Switches**

**Flat Plunger Type  
(without Ground Terminal)  
B3F-6000, B3F-6002**

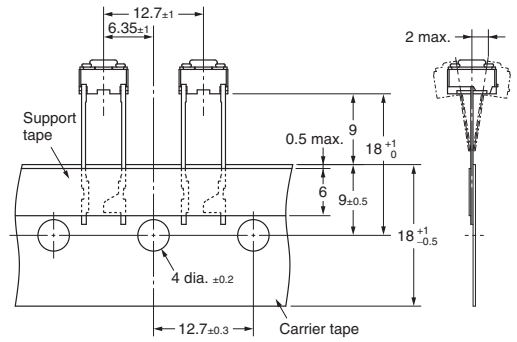
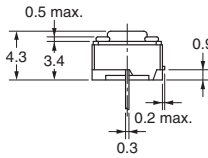
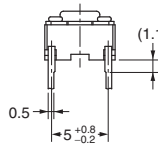
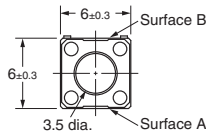
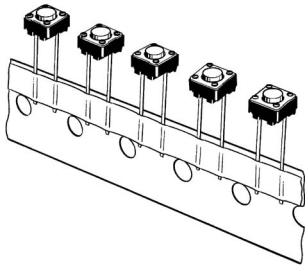

**Note:** The tape is random between surface A and surface B.

**PCB Mounting  
(Top View)  
(Single-sided PCB, t=1.6)**

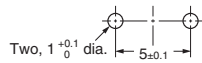

**Terminal Arrangement  
/Internal Connections  
(Top View)**

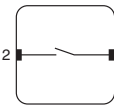

**Flat Plunger Type  
(with Ground Terminal)  
B3F-6100, B3F-6102**

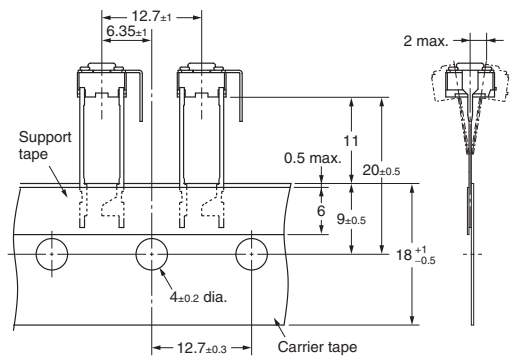
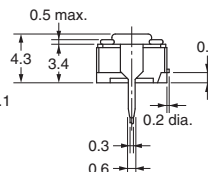
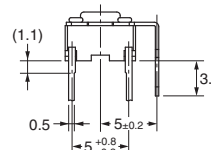
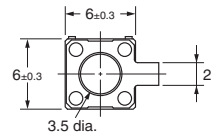
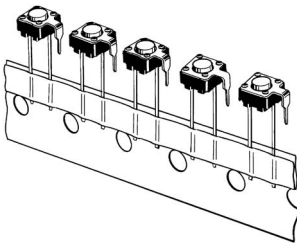

**PCB Mounting  
(Top View)  
(Single-sided PCB, t=1.6)**

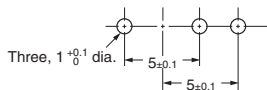

**Terminal Arrangement  
/Internal Connections  
(Top View)**

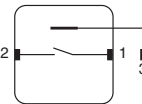

**Flat Plunger Type  
(without Ground Terminal)  
B3F-6020, B3F-6022**

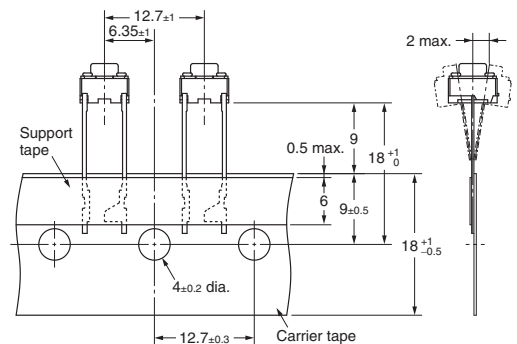
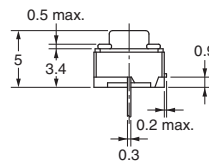
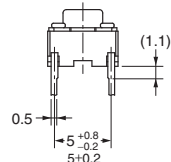
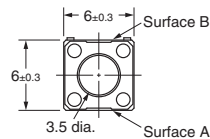
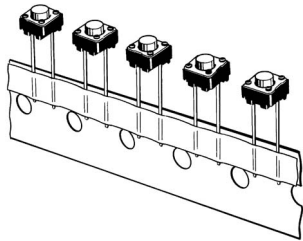

**Note:** The tape is random between surface A and surface B.

**PCB Mounting  
(Top View)  
(Single-sided PCB, t=1.6)**

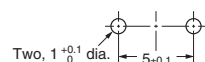

**Terminal Arrangement  
/Internal Connections  
(Top View)**

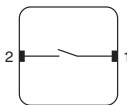

**Note:** Unless otherwise specified, a tolerance of ±0.4 mm applies to all dimensions. No terminal numbers are indicated on the Switches.

**Flat Plunger Type  
(with Ground Terminal)  
B3F-6120, B3F-6122**

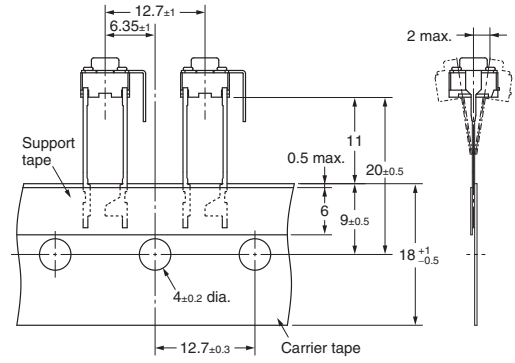
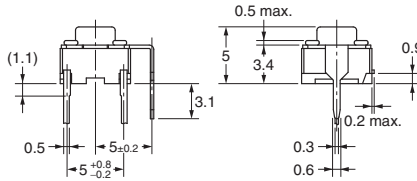
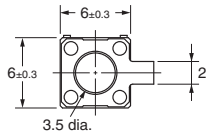
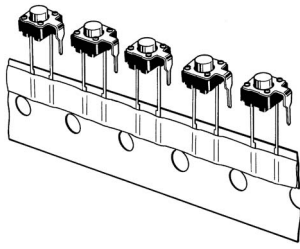

**PCB Mounting  
(Top View)  
(Single-sided PCB, t=1.6)**

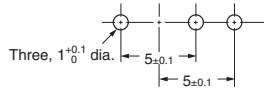

**Terminal Arrangement  
/Internal Connections  
(Top View)**

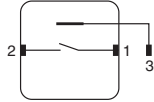

**Projected Plunger Type  
(without Ground Terminal)  
B3F-6050, B3F-6052**

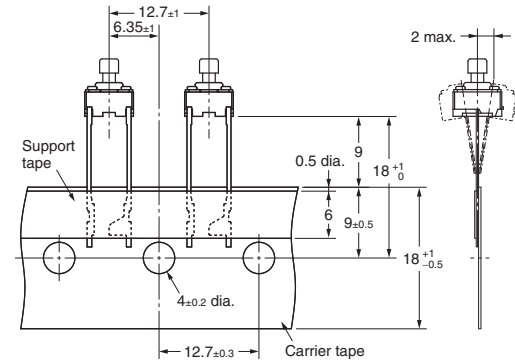
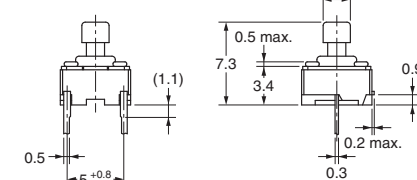
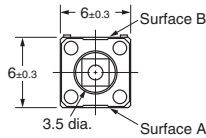
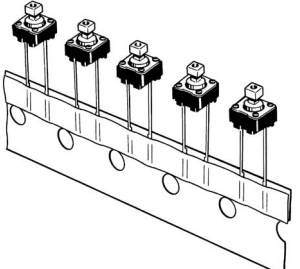

**PCB Mounting  
(Top View)  
(Single-sided PCB, t=1.6)**

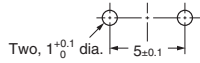

**Terminal Arrangement  
/Internal Connections  
(Top View)**

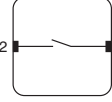

**Note:** The tape is random between surface A and surface B.

**Projected Plunger Type  
(with Ground Terminal)  
B3F-6150, B3F-6152**

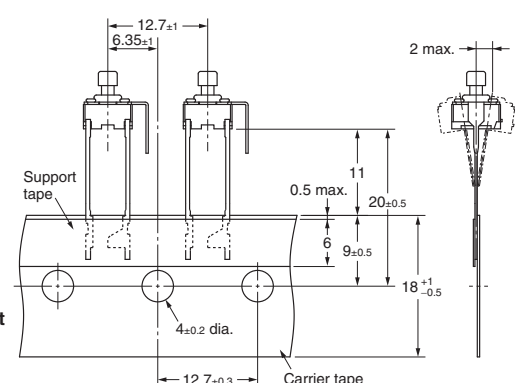
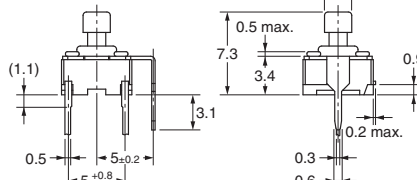
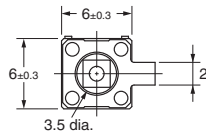
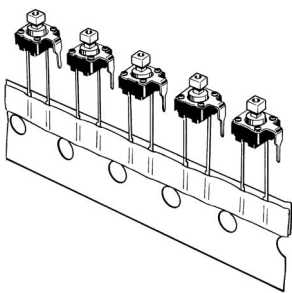

**PCB Mounting  
(Top View)  
(Single-sided PCB, t=1.6)**

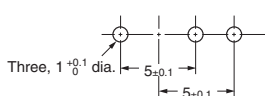

**Terminal Arrangement  
/Internal Connections  
(Top View)**

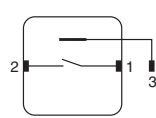

**Note:** Unless otherwise specified, a tolerance of ±0.4 mm applies to all dimensions. No terminal numbers are indicated on the Switches.



## ■ Key Tops

B32-series Special Key Tops are available for projected plunger models. Refer to the Datasheet of B32 for details.

## ■ Precautions

Be sure to read the safety precautions common to all Tactile Switches for correct use.

- Application examples provided in this document are for reference only. In actual applications, confirm equipment functions and safety before using the product.
- Consult your OMRON representative before using the product under conditions which are not described in the manual or applying the product to nuclear control systems, railroad systems, aviation systems, vehicles, combustion systems, medical equipment, amusement machines, safety equipment, and other systems or equipment that may have a serious influence on lives and property if used improperly. Make sure that the ratings and performance characteristics of the product provide a margin of safety for the system or equipment, and be sure to provide the system or equipment with double safety mechanisms.

**Note: Do not use this document to operate the Unit.**

**OMRON Corporation**

ELECTRONIC AND MECHANICAL COMPONENTS COMPANY

Contact: [www.omron.com/ecb](http://www.omron.com/ecb)

Cat. No. A070-E1-07  
0812(0207)(O)