

# PLCC2 SMD Side View Package LED SMS1105PKD, PINK

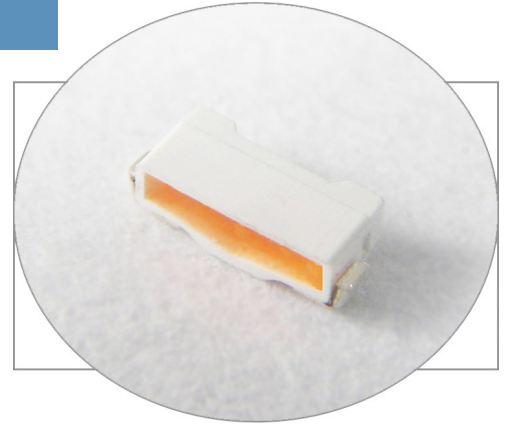

## SMS1105PKD

- ◆ Industry Standard Footprint
- ◆ Side Viewing, Low Profile Package
- ◆ High Luminous Intensity
- ◆ Wide Viewing Angle
- ◆ High Power Efficiency



Bivar SMS1105 LED is offered in a side viewing PLCC2 package exhibiting high luminous intensity and wide viewing angles. The miniature package is ideal for small scale applications such as displays, general indication, and backlighting. Low power consumption and excellent long life reliability are suitable for battery powered equipment where minimal maintenance is required. Wide variety of color and intensity combinations are available to meet any illumination needs. Bivar SMS1105 LED is packaged in standard tape and reels for pick and place assemblies.

Part Number	Material	Emitted Color	Lumen Typ. mcd	Lens Color	Viewing Angle
SMS1105PKD	InGaN	Pink	200	Diffused	120°

## Outline Dimensions

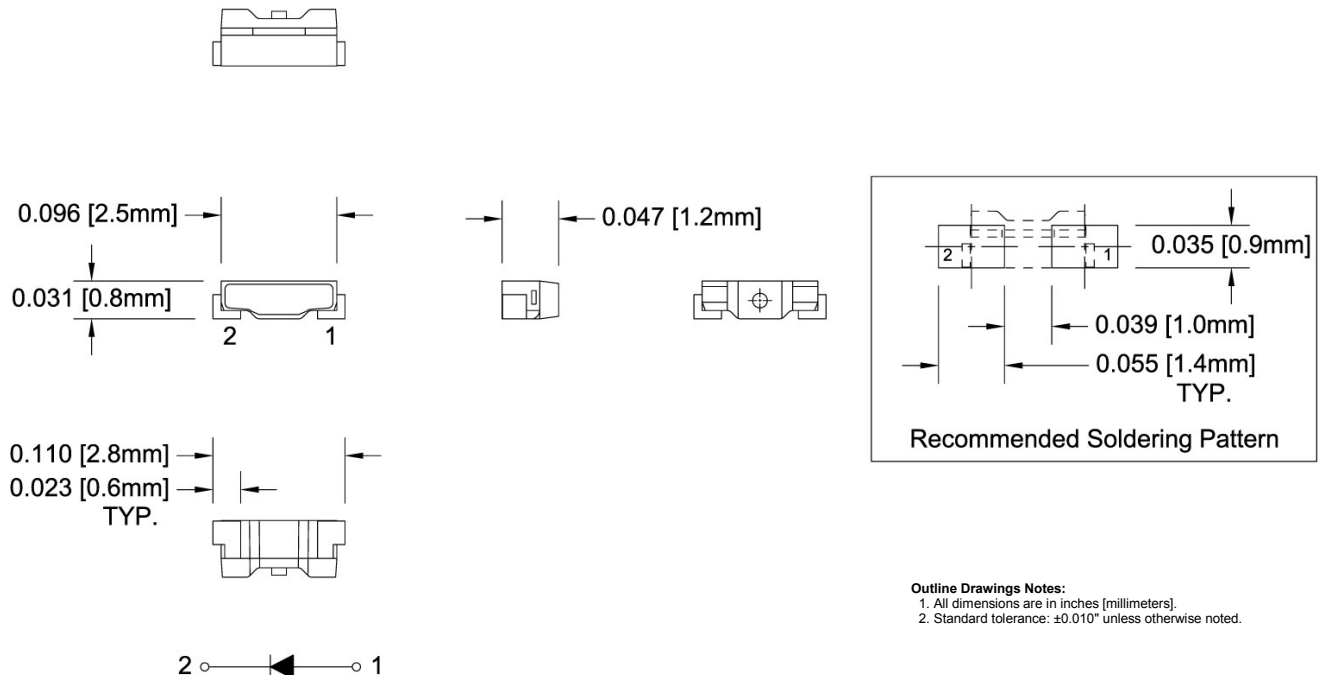

**Outline Drawings Notes:**  
 1. All dimensions are in inches [millimeters].  
 2. Standard tolerance: ±0.010" unless otherwise noted.



Bivar reserves the right to make changes at any time without notice.

# PLCC2 SMD Side View Package LED SMS1105PKD, PINK



## Absolute Maximum Ratings

$T_A = 25^\circ\text{C}$  unless otherwise noted

Power Dissipation	100 mW
Continuous Forward Current	30 mA
Peak Forward Current <sup>1</sup>	100 mA
Electrostatic Discharge Classification (HBM)	2000 V
Reverse Voltage	5 V
Derating Linear From 25°C	0.4 mA/°C
Operating Temperature Range	-30 ~ +85°C
Storage Temperature Range	-40 ~ +100°C
Soldering Temperature	260°C

- Notes: 1. 10% Duty Cycle, Pulse Width  $\leq 0.1$  msec.  
2. Solder time less than 5 seconds at temperature extreme.

## Electrical Characteristics

$T_A = 25^\circ\text{C}$  &  $I_F = 20$  mA unless otherwise noted

Emitting Color	Forward Voltage (V) <sup>1</sup>			Recommend Forward Current (mA)	Reverse Current ( $\mu\text{A}$ ) $V_R=5\text{V}$	Chromaticity Coordinates (XY) <sup>2</sup>	Luminous Intensity (mcd) <sup>3</sup>		Viewing Angle $2\theta_{1/2}$ (deg)
	MIN	TYP	MAX	TYP	MAX	TYP	MIN	MAX	TYP
Pink	3.0	3.4	3.8	20	10	X=0.455, Y=0.215	100	300	120

- Notes: 1. Tolerance of Forward Voltage :  $\pm 0.05\text{V}$ .  
2. Tolerance of Chromaticity Coordinates :  $\pm 0.02$ .  
3. Tolerance of Luminous Intensity :  $\pm 15\%$ .

## Directivity Radiation

$T_A = 25^\circ\text{C}$  unless otherwise noted

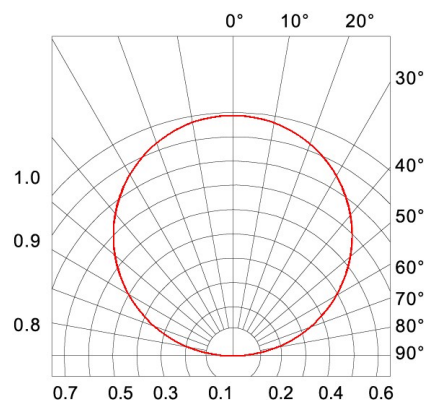

Radiation Diagram

Bivar reserves the right to make changes at any time without notice.

# PLCC2 SMD Side View Package LED SMS1105PKD, PINK



## Typical Electrical / Optical Characteristics Curves

$T_A = 25^\circ\text{C}$  unless otherwise noted

Relative Spectrum Emission  $I_{rel} = f(\lambda)$ ,  $T_A = 25^\circ\text{C}$ ,  $I_F = 20\text{ mA}$   
 $V(\lambda)$  = Standard eye response curve

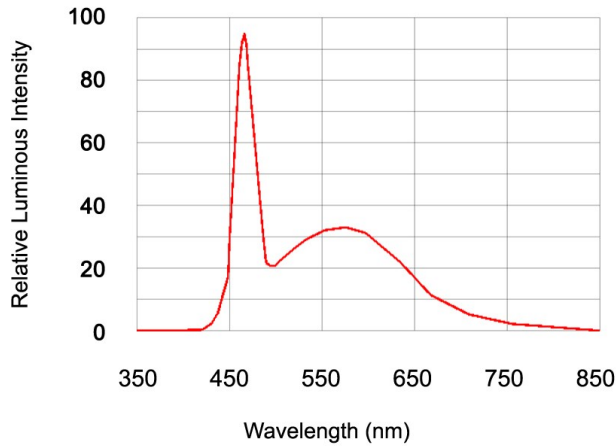

Fig.1 Relative Luminous Intensity vs. Wavelength

Forward Current  $I_F = f(V_F)$   
 $T_A = 25^\circ\text{C}$

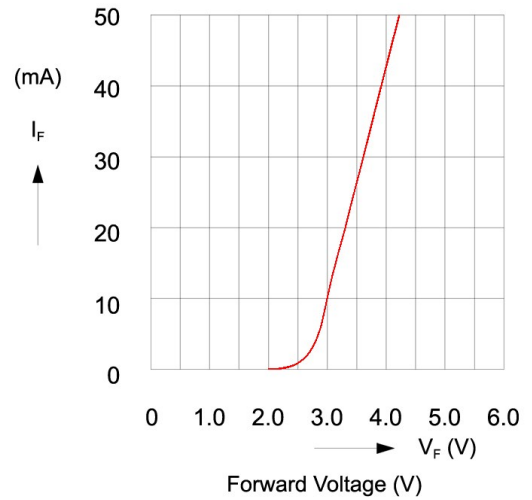

Fig.2 Forward Current vs. Forward Voltage

Relative Luminous Intensity  $I_V/I_V(20\text{mA}) = f(I_F)$   
 $T_A = 25^\circ\text{C}$

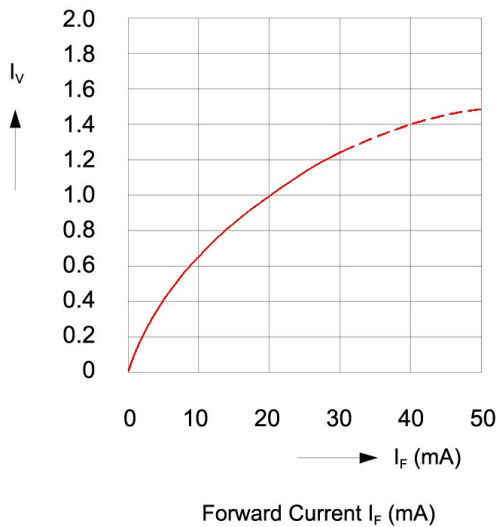

Fig.3 Relative Luminous Intensity vs. Forward Current

Ambient Temperature vs. Allowable Forward Current

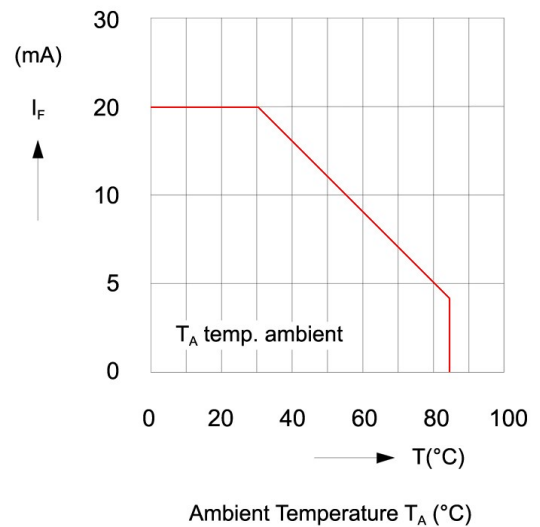
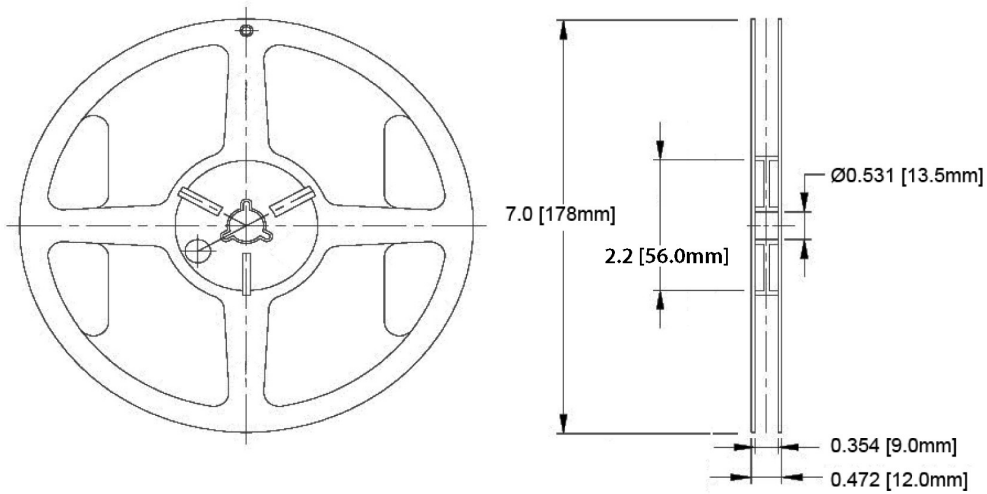

Fig.4 Forward Current vs. Ambient Temperature

Bivar reserves the right to make changes at any time without notice.



# PLCC2 SMD Side View Package LED SMS1105PKD, PINK



#### Outline Drawings Notes:

1. All dimensions are in inches [millimeters].
2. Standard tolerance unless otherwise noted: X.XXX ± 0.010"  
X.X ± 0.1"

## Packaging and Labeling Plan

Note: 1 Reel / Bag

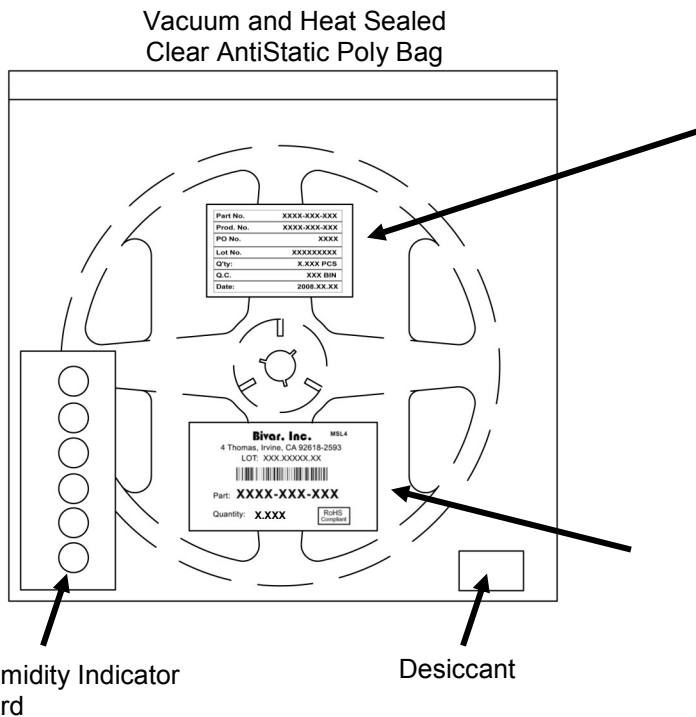

Part No.	XXXX-XXX-XXX
Prod. No.	XXXX-XXX-XXX
PO No.	XXXX
Lot No.	XXXXXXXXXX
Q'ty:	X.XXX PCS
Q.C.	XXX BIN
Date:	2008.XX.XX

Internal Quality Control Label

**Bivar, Inc.** MSL4  
4 Thomas, Irvine, CA 92618-2593  
LOT: XXX.XXXXX.XX

Part: **XXXX-XXX-XXX**  
Quantity: **X.XXX**

RoHS Compliant

Bivar Standard Packaging Label

Bivar reserves the right to make changes at any time without notice.