

LAYOUT INSPECTION

12



70.00±0.20

2.80±0.20



38.10±0.20

30.48±0.20

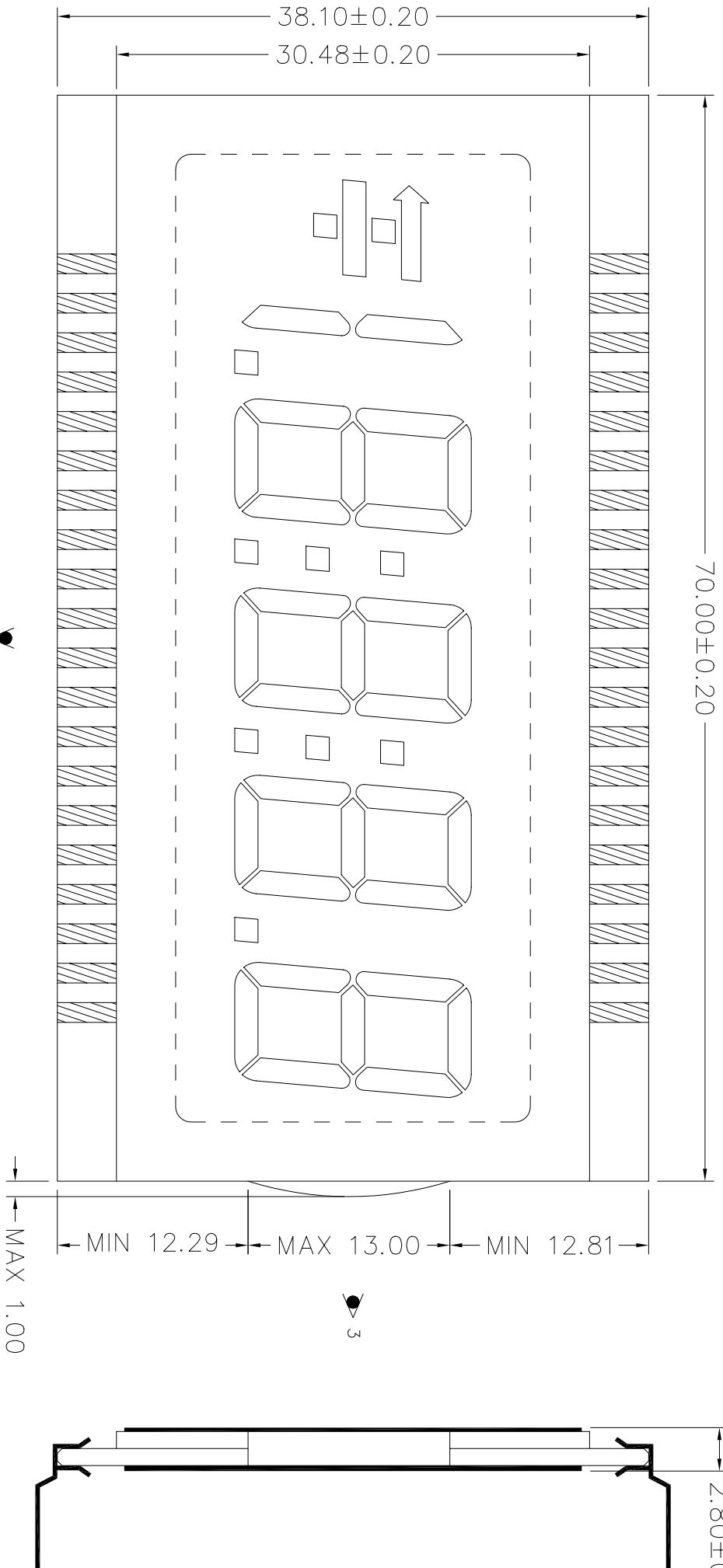

6

REMARKS : "◇" SPECIAL CHARACTERISTIC
 " + " SAFETY CHARACTERISTIC
 " () " REFERENCE ONLY
 "▽" CUSTOMER CRITICAL DIMENSION

<p>VARITRONIX LTD.</p>		<p>Dimension : mm</p>		<p>TOL : ±0.15 IF NOT SPECIFY</p>		<p>DD NOT SCALE DRAWING</p>		<p>3rd ANGLE PROJECTION</p>	
<p>DWGNO : VI-511-1</p>		<p>Drawn by : QJING</p>		<p>SIGN :</p>		<p>Date : 2002-09-02</p>			
<p>REV : 0</p>		<p>Checked by : MAKD</p>		<p>SIGN :</p>		<p>Date :</p>			

DWG.NO. : VI-511-1 (REV.0)

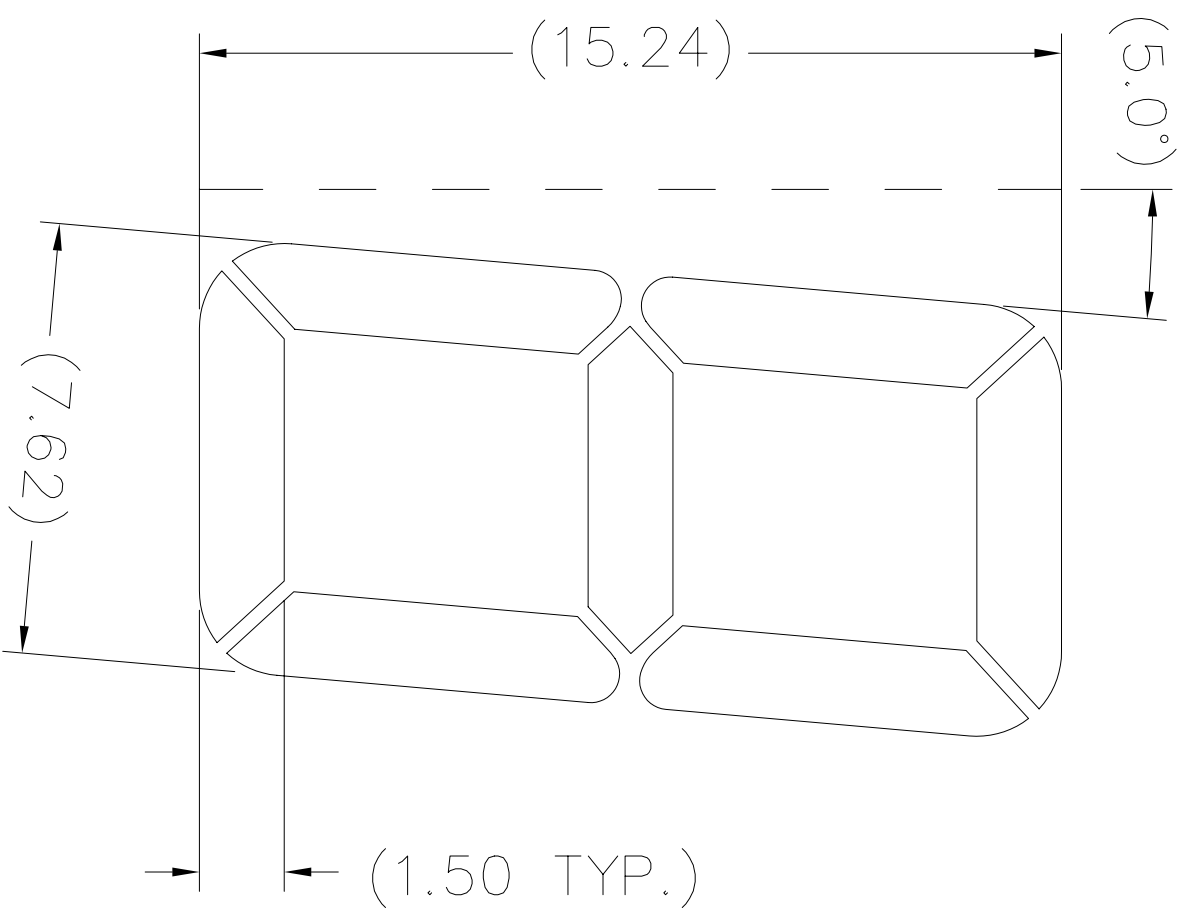

DIGIT 1 - 4

SEGMENT TRACKING

40

21

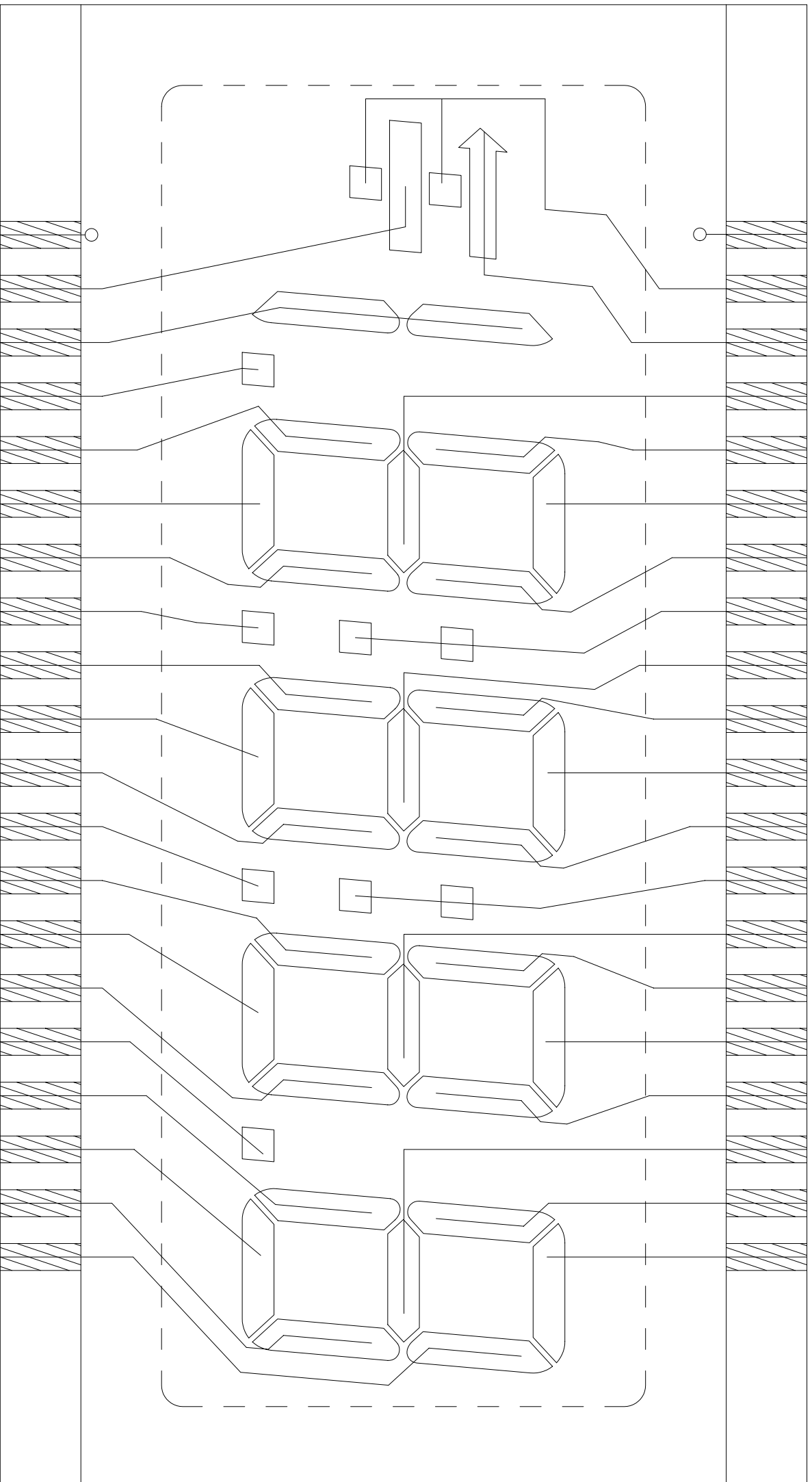

COM
1

20

REMARK: N.C. = NO CONNECTION

COMMON TRACKING

40

21

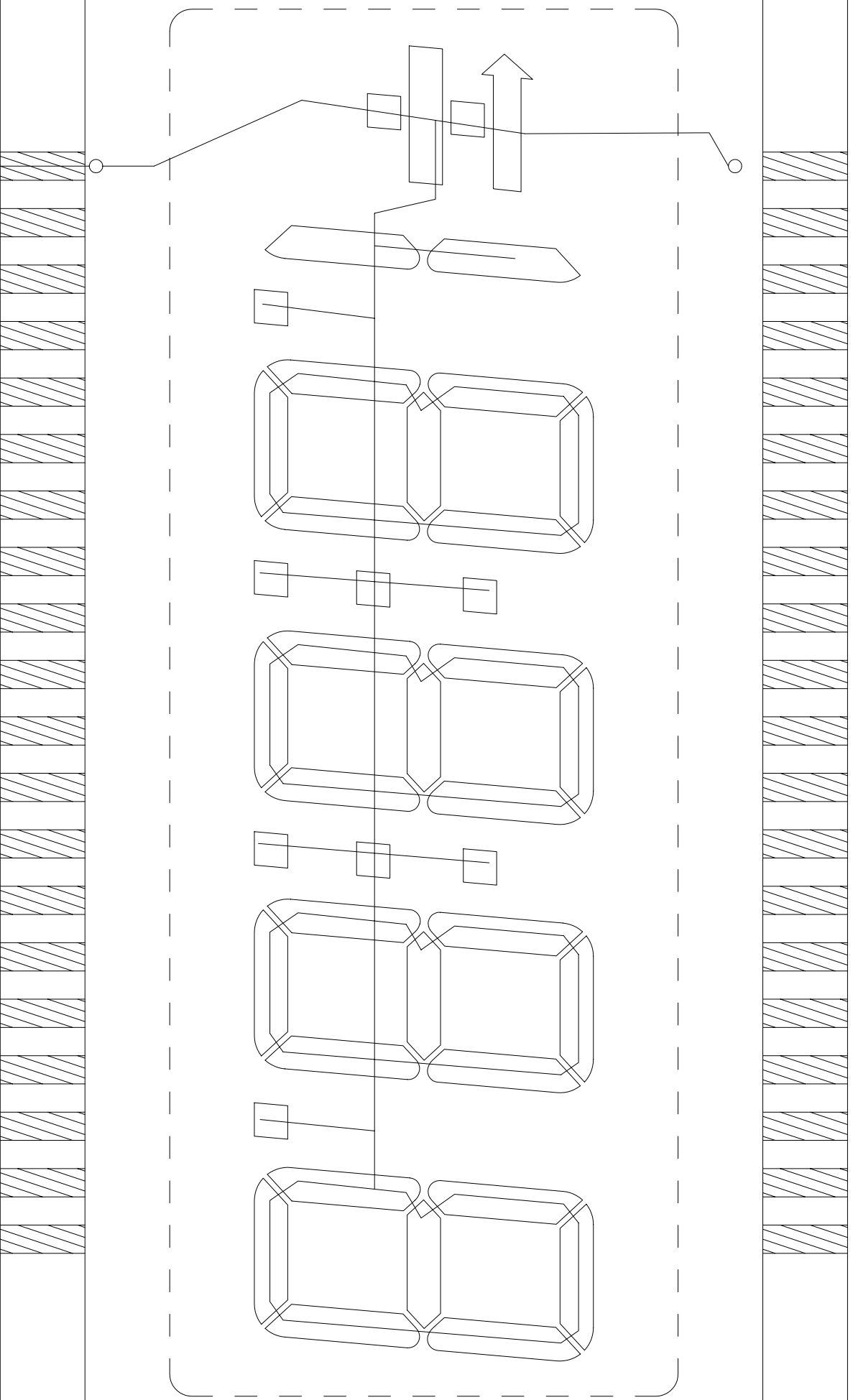

COM
REMARK: N.C. = NO CONNECTION

1

20

VARTRONIX LIMITED

POLARIZER LOCATION DIAGRAM

OPEN LAYER :

P

SCALE

Do not scale

Drawn by : QING

Date : 2002-09-02

Checked by : INA

Date : 2002-09-02

Approval by :

Date : 2002-09-02

DOC. NO. : PL-VI-511-1-01

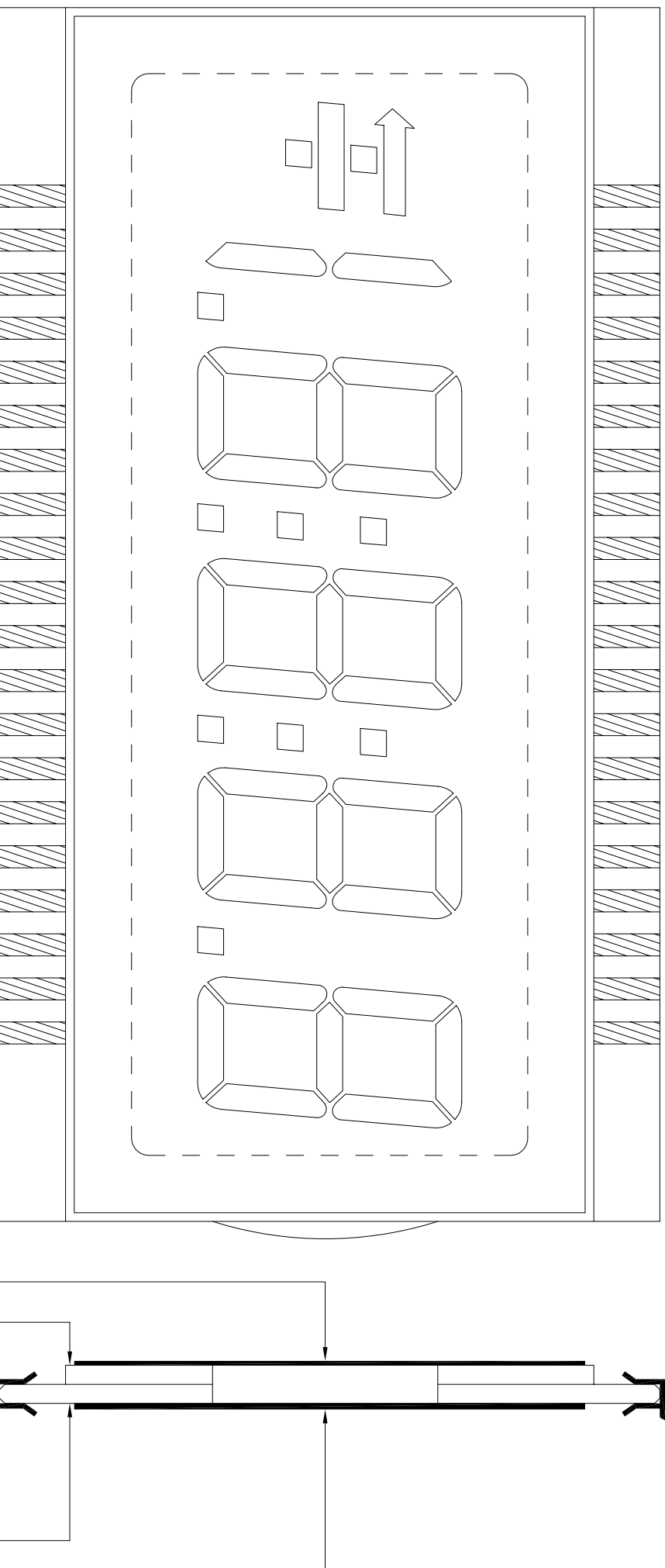

FRONT POLARIZER

FRONT GLASS

BACK GLASS

BACK POLARIZER

VARITRONIX LIMITED		OPEN LAYER :	SCALE
DIL-PIN DETAILS LOCATION DIAGRAM		DP-L0	Do not scale
DOC. NO. : DP-VI-511-1-01	Drawn by : QNG	Date : 2002/09/02	
	Checked by : YIN	Date : 2002/09/03	
ALL DIMENSIONS IN mm	Approval by :	Date : 2002/09/03	

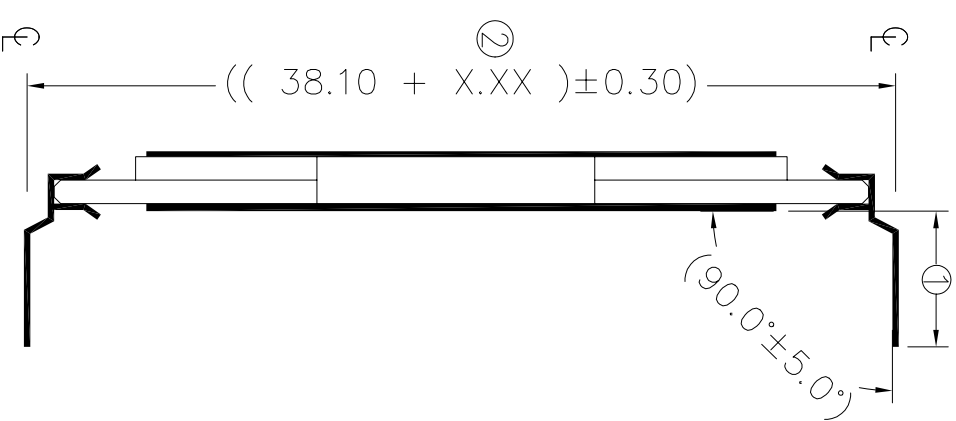
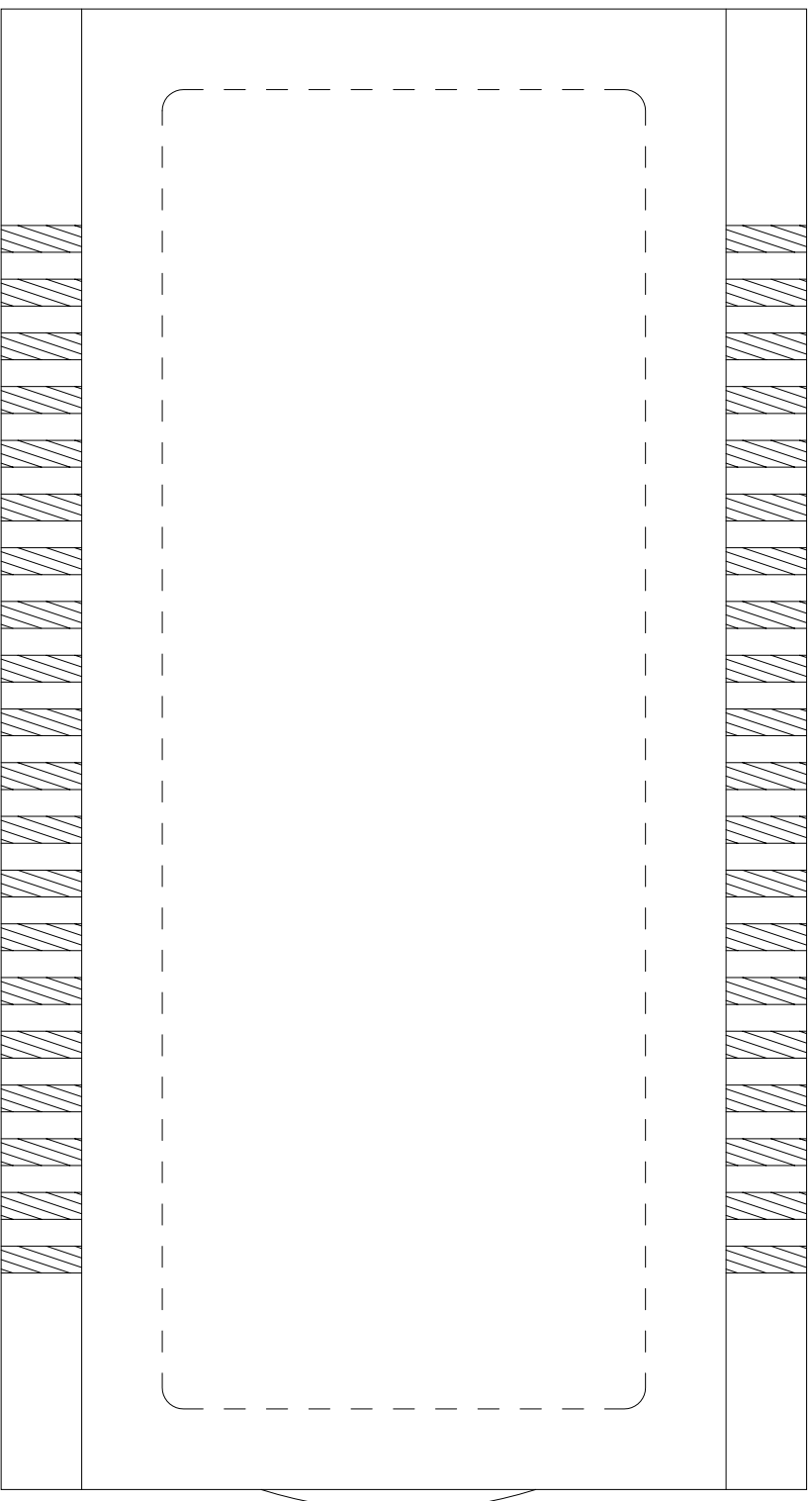

REMARKS: ① REFER TO COVER PAGE

② ----- X.XX=2.54 (FOR PIN LENGTH \geq 3.20 & \leq 10.00mm)

----- X.XX=1.75 (FOR PIN LENGTH $>$ 10.00 & \leq 19.50mm)

DWG.NO. : VI-511-1 (REV.0)

PIN	COM	PIN	COM
1	COM	21	1A
2	Y	22	1F
3	K	23	1G
4	4DP	24	2B
5	4E	25	2A
6	4D	26	2F
7	4C	27	2G
8	3DP	28	1L
9	3E	29	3B
10	3D	30	3A
11	3C	31	3F
12	2DP	32	3G
13	2E	33	2L
14	2D	34	4B
15	2C	35	4A
16	1DP	36	4F
17	1E	37	4G
18	1D	38	Z
19	1C	39	X
20	1B	40	COM

REMARK : N.C. = NO CONNECTION