

EPC2815 – Enhancement Mode Power Transistor

 $V_{DSS}, 40\text{ V}$
 $R_{DS(ON)}, 4\text{ m}\Omega$
 $I_D, 33\text{ A}$

High Lead Bump Finish: 95%Pb/5%Sn

NEW PRODUCT

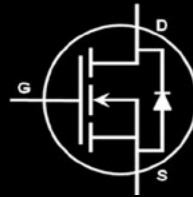

Gallium Nitride is grown on Silicon Wafers and processed using standard CMOS equipment leveraging the infrastructure that has been developed over the last 55 years. GaN's exceptionally high electron mobility and low temperature coefficient allows very low $R_{DS(ON)}$, while its lateral device structure and majority carrier diode provide exceptionally low Q_G and zero Q_{RR} . The end result is a device that can handle tasks where very high switching frequency, and low on-time are beneficial as well as those where on-state losses dominate.



EPC2815 eGaN® FETs are supplied only in passivated die form with solder bars

Applications

- High Speed DC-DC conversion
- Class D Audio
- Hard Switched and High Frequency Circuits

Benefits

- Ultra High Efficiency
- Ultra Low $R_{DS(on)}$
- Ultra low Q_G
- Ultra small footprint

Maximum Ratings

V_{DS}	Drain-to-Source Voltage (Continuous)	40	V
	Drain-to-Source Voltage (up to 10,000 5ms pulses at 125° C)	48	V
I_D	Continuous ($T_A = 25^\circ\text{C}, \theta_{JA} = 13$)	33	A
	Pulsed (25° C, $T_{\text{pulse}} = 300\ \mu\text{s}$)	150	A
V_{GS}	Gate-to-Source Voltage	6	V
	Gate-to-Source Voltage	-5	V
T_J	Operating Temperature	-40 to 150	°C
T_{STG}	Storage Temperature	-40 to 150	

PARAMETER	TEST CONDITIONS	MIN	TYP	MAX	UNIT	
Static Characteristics ($T_J = 25^\circ\text{C}$ unless otherwise stated)						
BV_{DSS}	Drain-to-Source Voltage	$V_{GS} = 0\text{ V}, I_D = 500\ \mu\text{A}$	40		V	
I_{DSS}	Drain Source Leakage	$V_{DS} = 32\text{ V}, V_{GS} = 0\text{ V}$		200	400	μA
I_{GSS}	Gate-Source Forward Leakage	$V_{GS} = 5\text{ V}$		1.5	7	mA
	Gate-Source Reverse Leakage	$V_{GS} = -5\text{ V}$		0.3	1.5	
$V_{GS(TH)}$	Gate Threshold Voltage	$V_{DS} = V_{GS}, I_D = 9\text{ mA}$	0.7	1.4	2.5	V
$R_{DS(ON)}$	Drain-Source On Resistance	$V_{GS} = 5\text{ V}, I_D = 33\text{ A}$		3.2	4	$\text{m}\Omega$
Source-Drain Characteristics ($T_J = 25^\circ\text{C}$ unless otherwise stated)						
V_{SD}	Source-Drain Forward Voltage	$I_S = 0.5\text{ A}, V_{GS} = 0\text{ V}, T = 25^\circ\text{C}$		1.75		V
		$I_S = 0.5\text{ A}, V_{GS} = 0\text{ V}, T = 150^\circ\text{C}$		1.8		

All measurements were done with substrate shorted to source.

Thermal Characteristics

		TYP	
$R_{\theta JC}$	Thermal Resistance, Junction to Case	2.1	°C/W
$R_{\theta JB}$	Thermal Resistance, Junction to Board	15	°C/W
$R_{\theta JA}$	Thermal Resistance, Junction to Ambient (Note 1)	54	°C/W

Note 1: $R_{\theta JA}$ is determined with the device mounted on one square inch of copper pad, single layer 2 oz copper on FR4 board. See http://epc-co.com/epc/documents/product-training/Appnote_Thermal_Performance_of_eGaN_FETs.pdf for details.

PARAMETER		TEST CONDITIONS	MIN	TYP	MAX	UNIT
Dynamic Characteristics ($T_J = 25^\circ\text{C}$ unless otherwise stated)						
C_{ISS}	Input Capacitance	$V_{DS} = 20\text{ V}, V_{GS} = 0\text{ V}$		1100	1200	pF
C_{OSS}	Output Capacitance			575	750	
C_{RSS}	Reverse Transfer Capacitance			60	70	
Q_G	Total Gate Charge ($V_{GS} = 5\text{ V}$)	$V_{DS} = 20\text{ V}, I_D = 33\text{ A}$		10.5	11.6	nC
Q_{GD}	Gate to Drain Charge			2.2	2.7	
Q_{GS}	Gate to Source Charge			3	3.5	
Q_{OSS}	Output Charge	$V_{DS} = 20\text{ V}, V_{GS} = 0\text{ V}$		18.5	22	
Q_{RR}	Source-Drain Recovery Charge			0	0	

All measurements were done with substrate shorted to source.

Figure 1: Typical Output Characteristics

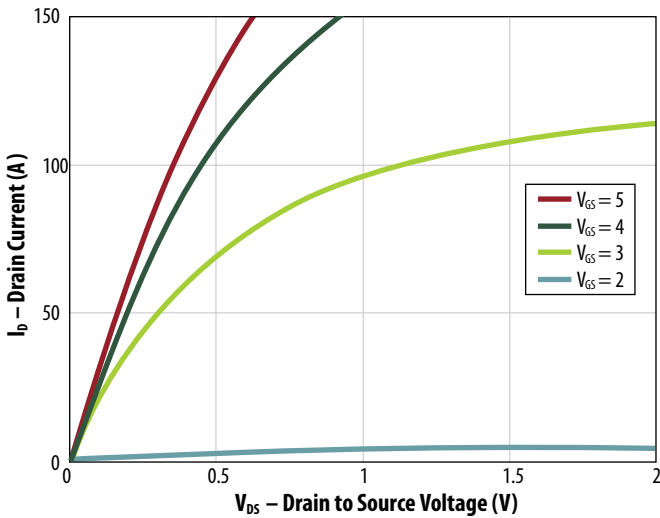

Figure 2: Transfer Characteristics

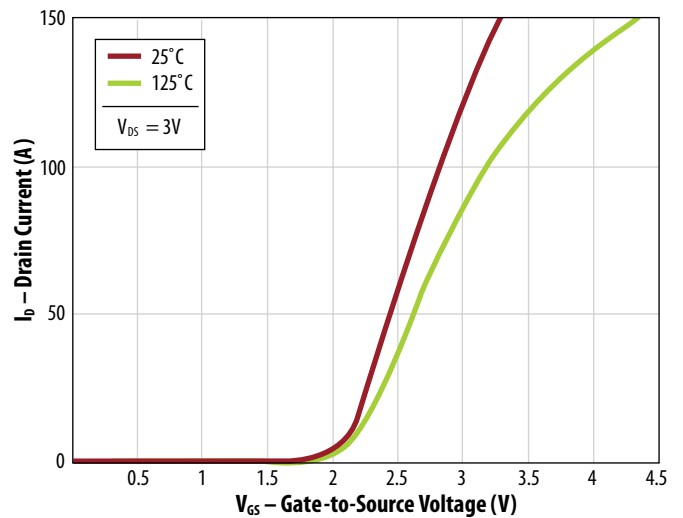

Figure 3: $R_{DS(on)}$ vs V_{GS} for Various Current

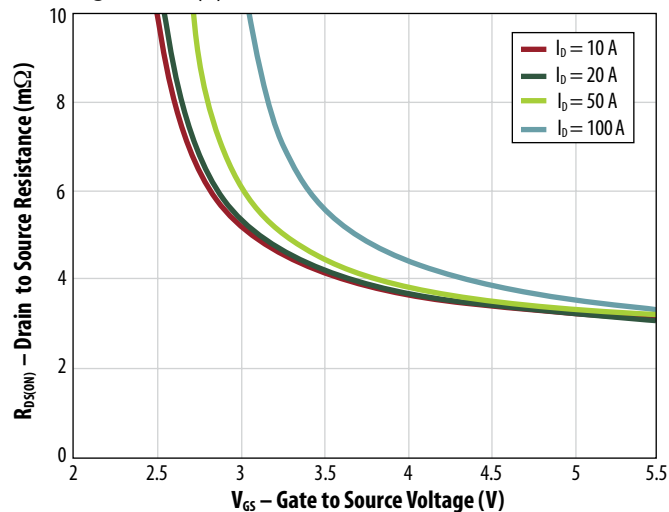

Figure 4: $R_{DS(on)}$ vs V_{GS} for Various Temperature

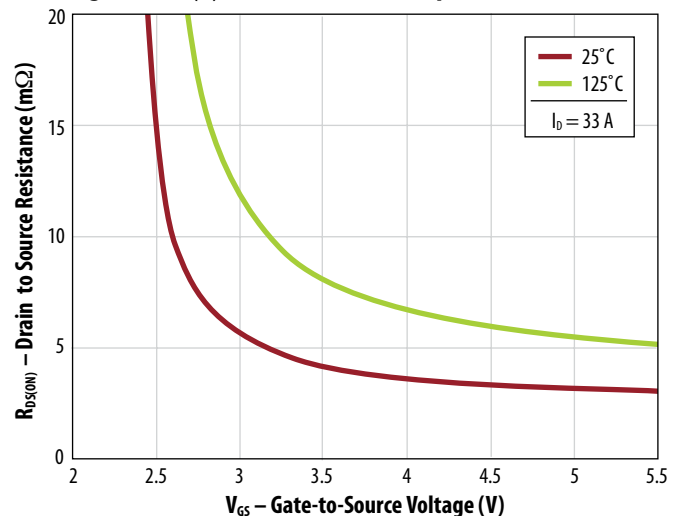

Figure 5: Capacitance

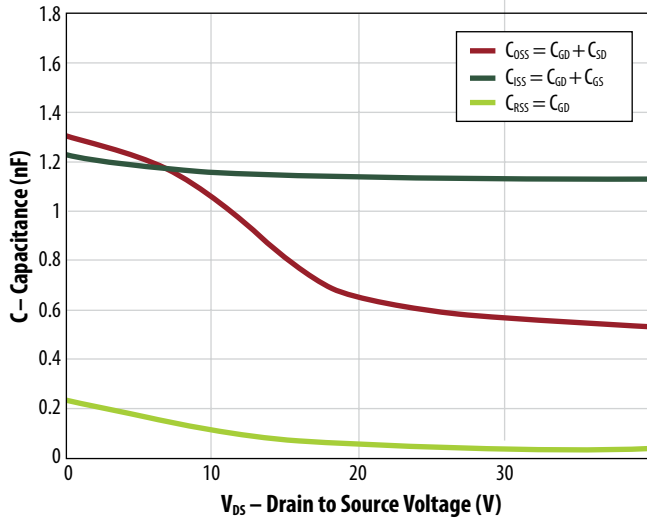

Figure 6: Gate Charge

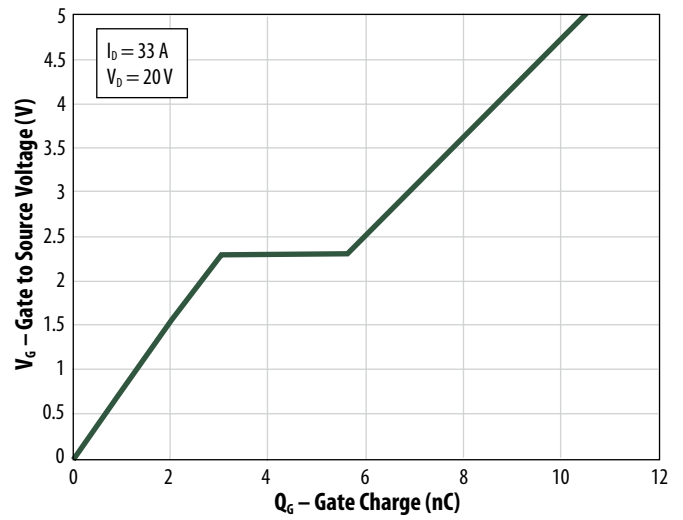

Figure 7: Reverse Drain-Source Characteristics

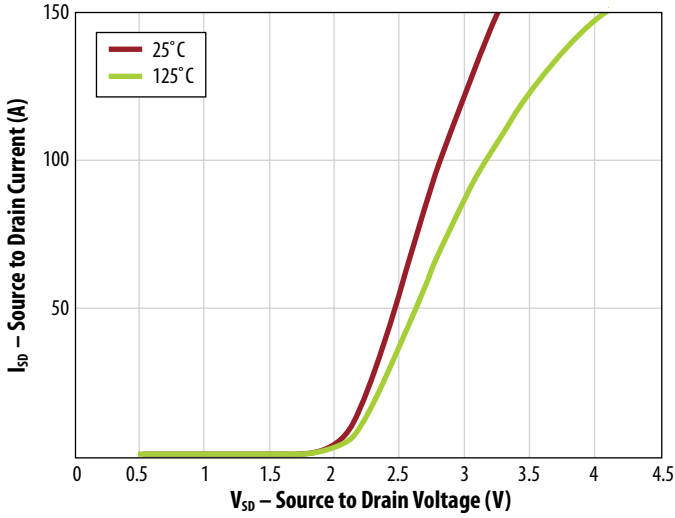

Figure 8: Normalized On Resistance Vs Temperature

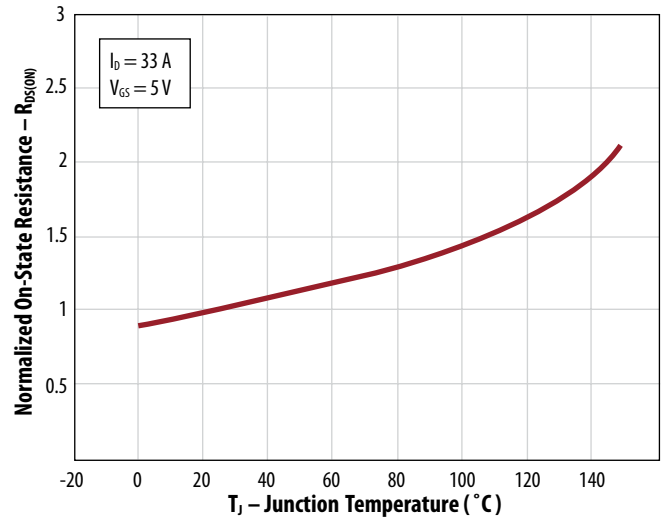

Figure 9: Normalized Threshold Voltage vs. Temperature

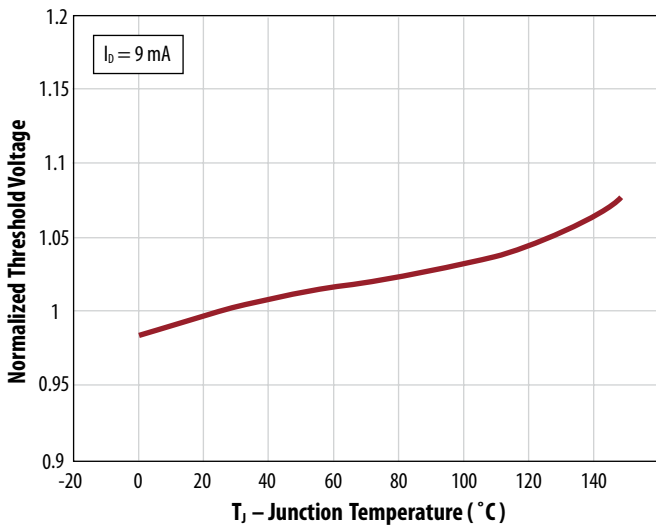
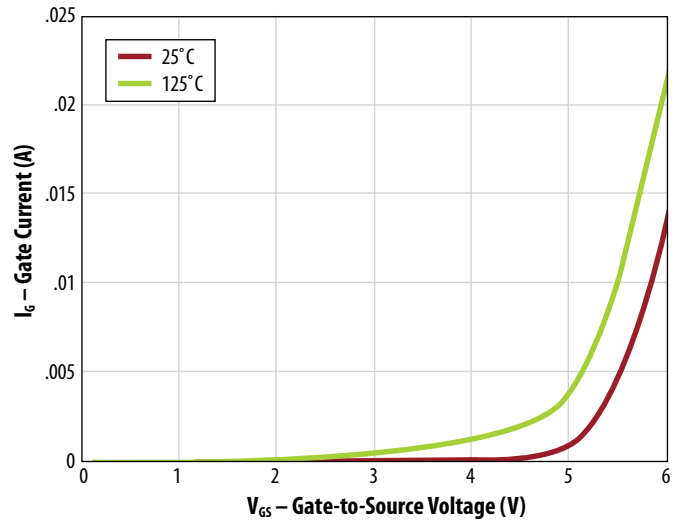

Figure 10: Gate Current



All measurements were done with substrate shorted to source.

Figure 11: Transient Thermal Response Curves

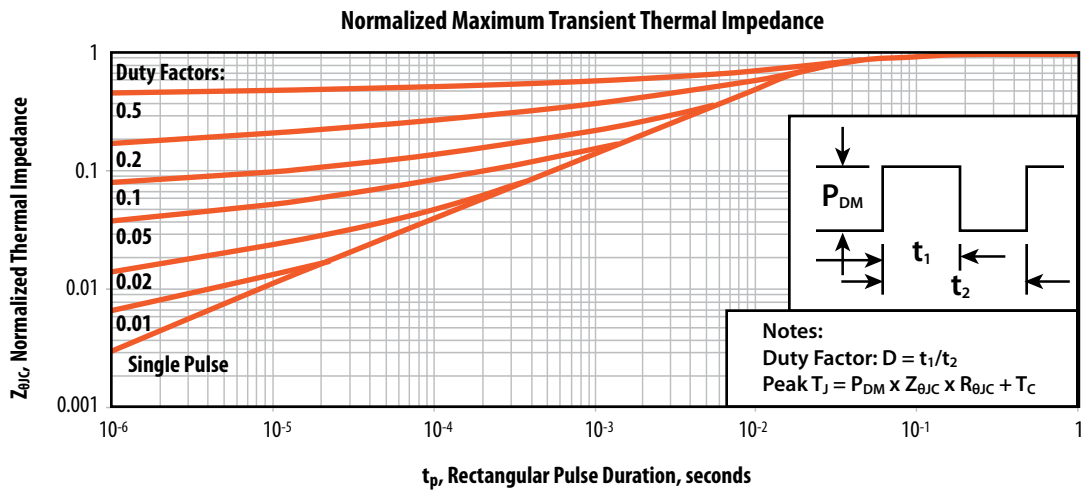
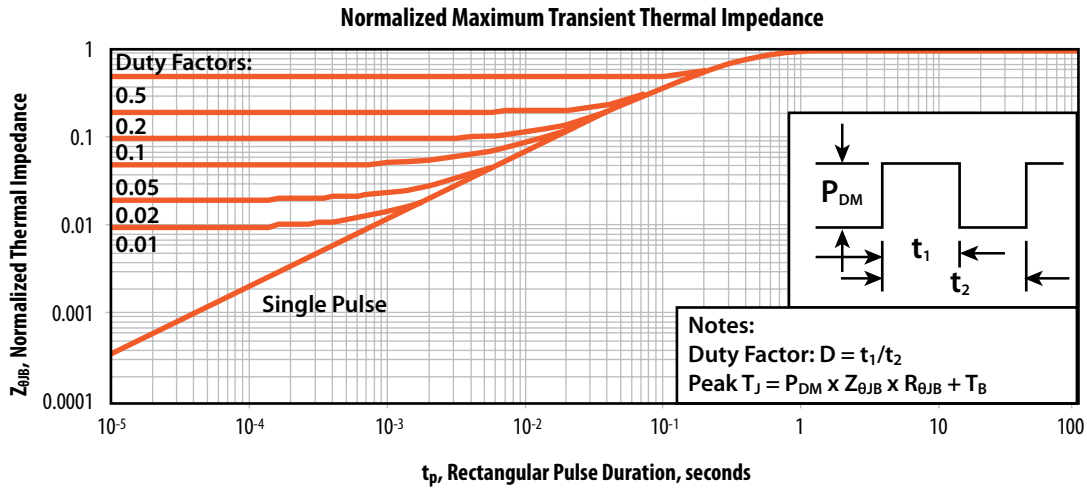
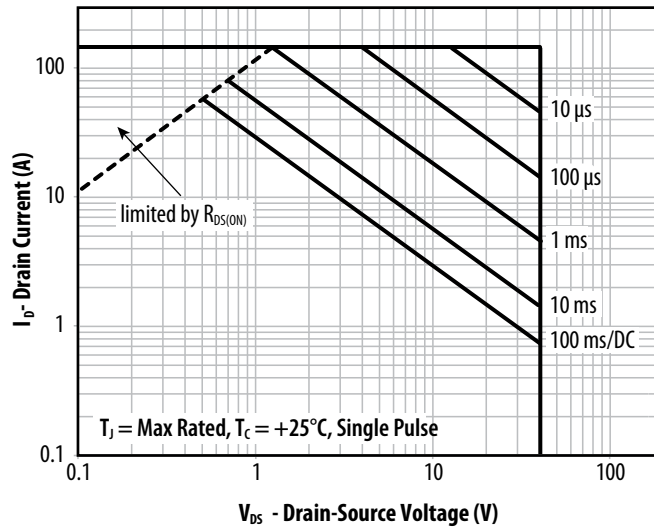
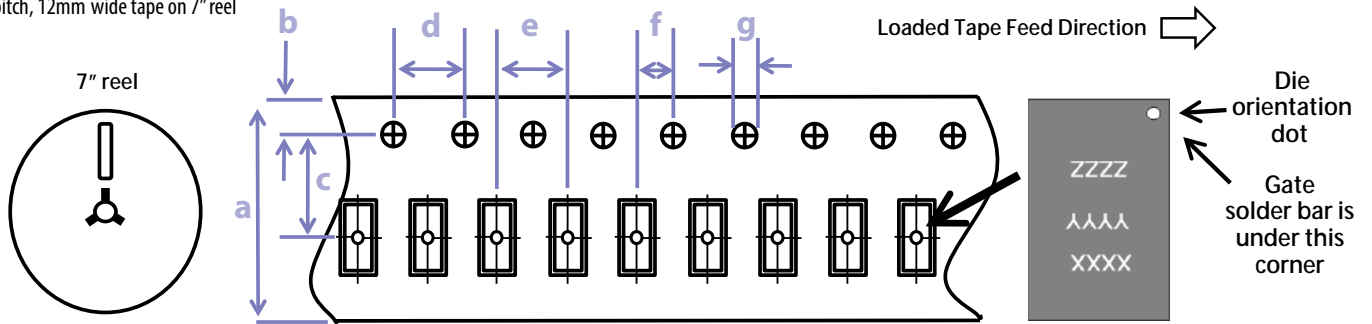

Figure 12: Safe Operating Area



TAPE AND REEL CONFIGURATION

4mm pitch, 12mm wide tape on 7" reel



Die is placed into pocket solder bar side down (face side down)

Dimension (mm)	EPC2815		
	target	min	max
a	12.0	11.7	12.3
b	1.75	1.65	1.85
c (note 2)	5.50	5.45	5.55
d	4.00	3.90	4.10
e	4.00	3.90	4.10
f (note 2)	2.00	1.95	2.05
g	1.5	1.5	1.6

Note 1: Pocket position is relative to the sprocket hole measured as true position of the pocket, not the pocket hole.

DIE MARKINGS

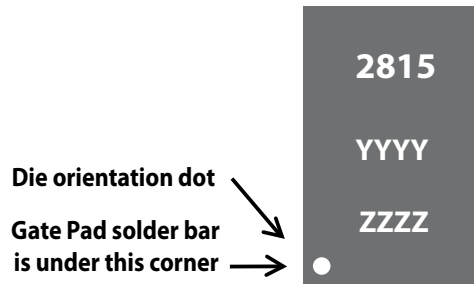

Part Number	Laser Markings		
	Part # Marking Line 1	Lot_Date Code Marking line 2	Lot_Date Code Marking Line 3
EPC2815	2815	YYYY	ZZZZ

DIE OUTLINE

Solder Bar View

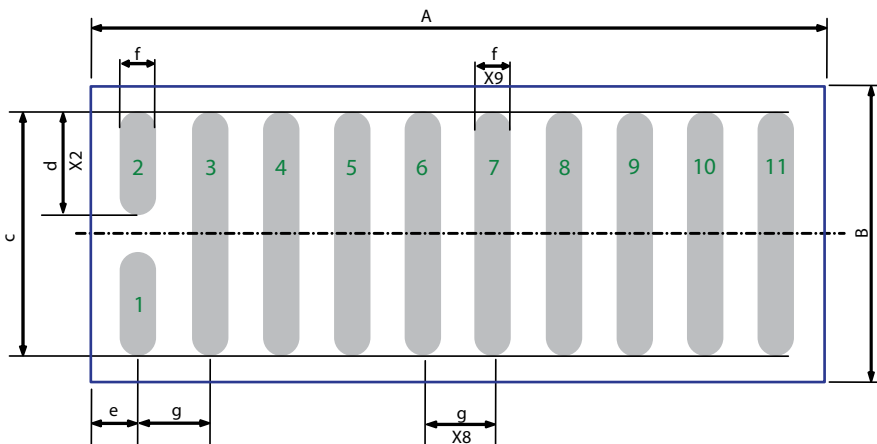

High Lead Bump Finish: 95%Pb/5%Sn

DIM	MICROMETERS		
	MIN	Nominal	MAX
A	4075	4105	4135
B	1602	1632	1662
c	1379	1382	1385
d	577	580	583
e	235	250	265
f	195	200	205
g	400	400	400

Side View

