



## SBR20100CT SCHOTTKY RECTIFIER

### Applications:

- Switching power supply
- Converters
- Free-Wheeling diodes
- Reverse battery protection

### Features:

- 150°C TJ operation
- Center tap configuration
- Low forward voltage drop
- High purity, high temperature epoxy encapsulation for enhanced mechanical strength and moisture resistance
- High frequency operation
- Guard ring for enhanced ruggedness and long term reliability
- This is a Pb – Free Device
- All SMC parts are traceable to the wafer lot
- Additional testing can be offered upon request

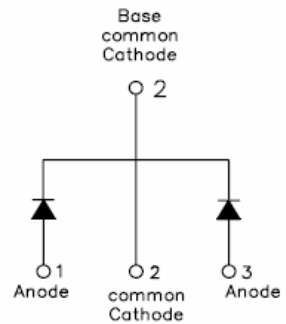

### Mechanical Dimensions (In mm / Inches) and Marking:

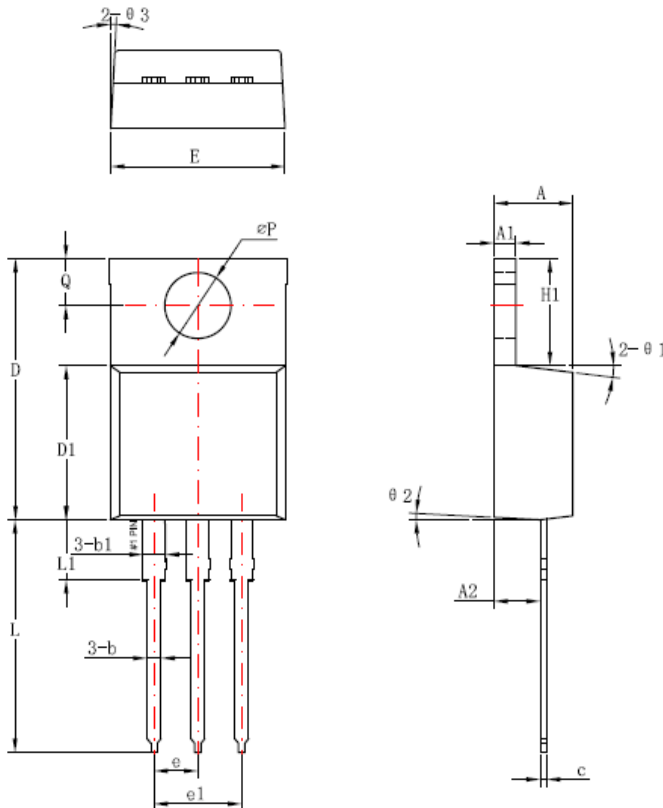

Symbol	Dimensions in millimeters		
	Min	Typical	Max
A	4.42	4.57	4.72
A1	1.17	1.27	1.37
A2	2.59	2.69	2.89
b	0.71	0.81	0.96
b1		1.27	
c	0.36	0.38	0.61
D	14.94	15.24	15.54
D1	8.85	9.00	9.15
E	10.01	10.16	10.31
e		2.54	
e1		5.06	
H1	6.04	6.24	6.44
L	12.7	13.56	13.78
L1		3.5	
ΦP	3.74	3.84	4.04
Q	2.54	2.74	2.94
Θ1		7°	
Θ2		3°	
Θ3		4°	

### OPTION1 (HD)

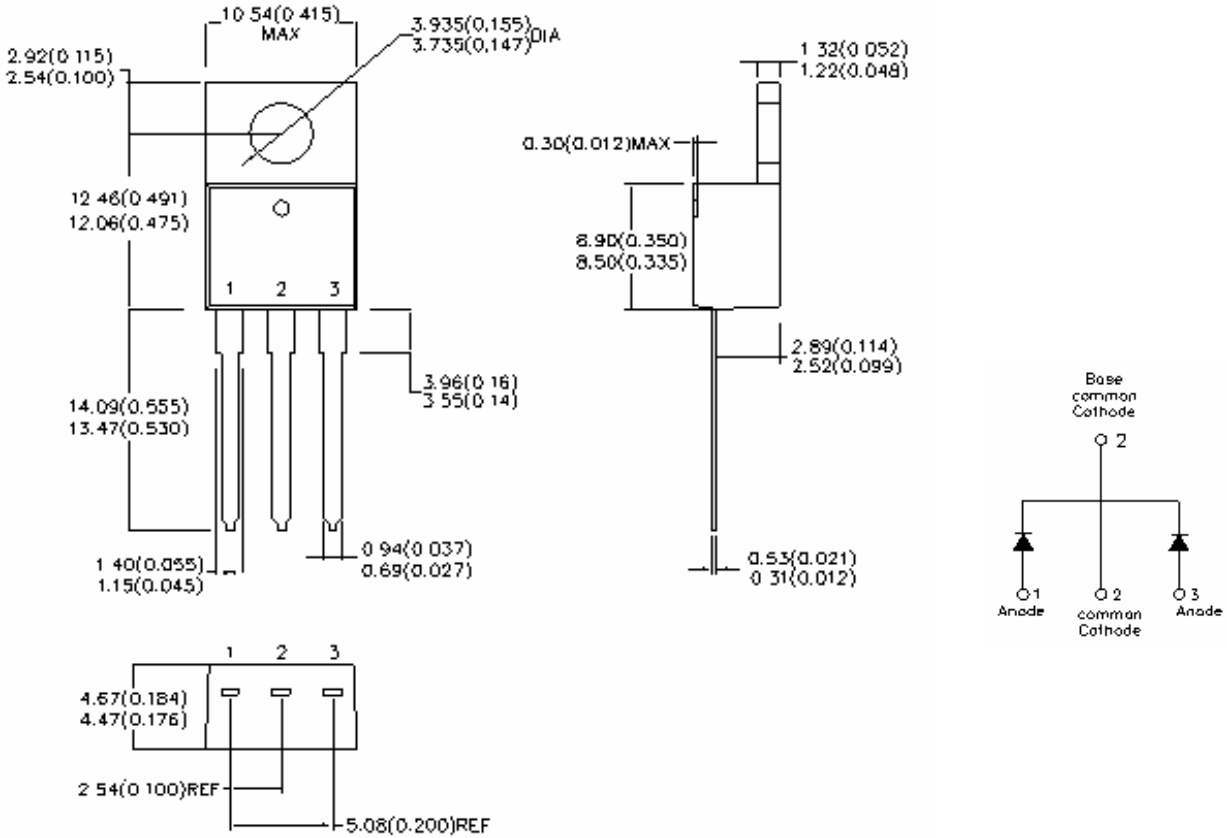

**OPTION2 (CJ)**

**TO-220AB**



**Marking Diagram:**

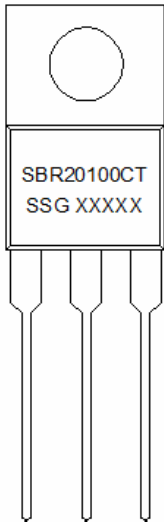

Where XXXXX is YYWWL

SBR = Device Type  
 20 = Forward Current (20A)  
 100 = Reverse Voltage (100V)  
 CT = Configuration  
 SSG = SSG  
 YY = Year  
 WW = Week  
 L = Lot Number

**Cautions:** Molding resin  
 Epoxy resin UL:94V-0

**Ordering Information:**

Device	Package	Shipping
SBR20100CT	TO-220AB (Pb-Free)	50 pcs / tube

For information on tape and reel specifications, including part orientation and tape sizes, please refer to our Tape and Reel Packaging Specification.

**Maximum Ratings:**

Characteristics	Symbol	Condition	Max.	Units
Peak Inverse Voltage	$V_{RWM}$	-	100	V
Max. Average Forward	$I_{F(AV)}$	50% duty cycle @ $T_C = 133^\circ C$ , rectangular wave form	10(Per leg) 20(Per device)	A
Max. Peak One Cycle Non-Repetitive Surge Current (per leg)	$I_{FSM}$	8.3 ms, half Sine pulse	150	A
Peak Repetitive Reverse Surge Current (per leg)	$I_{RRM}$	2.0s, 1.0KHz	0.5	A



**Electrical Characteristics:**

Characteristics	Symbol	Condition	Max.	Units
Max. Forward Voltage Drop (per leg)*	$V_{F1}$	@ 10A, Pulse, $T_J = 25\text{ }^\circ\text{C}$	0.90	V
	$V_{F2}$	@ 10A, Pulse, $T_J = 125\text{ }^\circ\text{C}$	0.80	V
Max. Reverse Current (per leg)*	$I_{R1}$	@ $V_R = \text{rated VR}$ $T_J = 25\text{ }^\circ\text{C}$	1.0	mA
	$I_{R2}$	@ $V_R = \text{rated VR}$ $T_J = 125\text{ }^\circ\text{C}$	6.0	mA
Max Junction Capacitance (per leg)	$C_J$	@ $V_R=5V, T_C=25\text{ }^\circ\text{C}$ $f_{SIG}=1\text{MHz}$	350	mA
Max. Voltage Rate of Change	dv/dt	-	10,000	V/s

\* Pulse Width < 300 $\mu$ s, Duty Cycle <2%

**Thermal-Mechanical Specifications:**

Characteristics	Symbol	Condition	Specification	Units
Max. Junction Temperature	$T_J$	-	-55 to +150	$^\circ\text{C}$
Max. Storage Temperature	$T_{stg}$	-	-55 to +150	$^\circ\text{C}$
Maximum Thermal Resistance Junction to Case (per leg)	$R_{\theta JC}$	DC operation	2.0	$^\circ\text{C/W}$
Approximate Weight	wt	-	2.0	g
Case Style	TO-220AB			

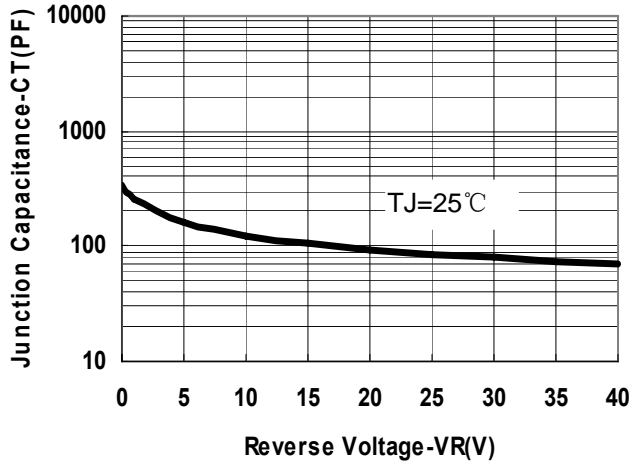

Fig.1-Typical Junction Capacitance

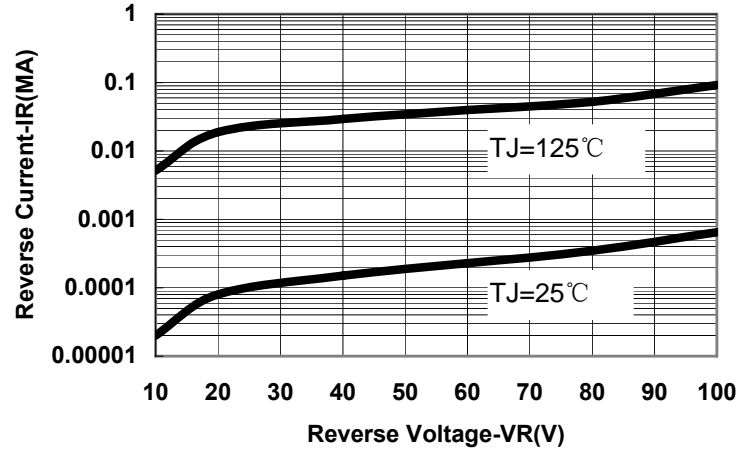

Fig.2-Typical Reverse Characteristics

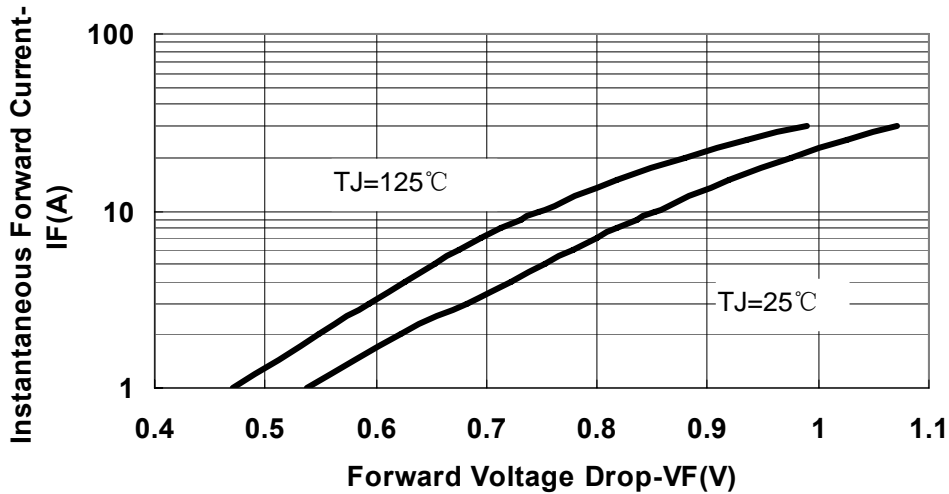

Fig.3-Typical Instantaneous Forward Voltage Characteristics



**DISCLAIMER:**

- 1- The information given herein, including the specifications and dimensions, is subject to change without prior notice to improve product characteristics. Before ordering, purchasers are advised to contact the SMC - Sangdest Microelectronics (Nanjing) Co., Ltd sales department for the latest version of the datasheet(s).
- 2- In cases where extremely high reliability is required (such as use in nuclear power control, aerospace and aviation, traffic equipment, medical equipment, and safety equipment), safety should be ensured by using semiconductor devices that feature assured safety or by means of users' fail-safe precautions or other arrangement.
- 3- In no event shall SMC - Sangdest Microelectronics (Nanjing) Co., Ltd be liable for any damages that may result from an accident or any other cause during operation of the user's units according to the datasheet(s). SMC - Sangdest Microelectronics (Nanjing) Co., Ltd assumes no responsibility for any intellectual property claims or any other problems that may result from applications of information, products or circuits described in the datasheets.
- 4- In no event shall SMC - Sangdest Microelectronics (Nanjing) Co., Ltd be liable for any failure in a semiconductor device or any secondary damage resulting from use at a value exceeding the absolute maximum rating.
- 5- No license is granted by the datasheet(s) under any patents or other rights of any third party or SMC - Sangdest Microelectronics (Nanjing) Co., Ltd.
- 6- The datasheet(s) may not be reproduced or duplicated, in any form, in whole or part, without the expressed written permission of SMC - Sangdest Microelectronics (Nanjing) Co., Ltd.
- 7- The products (technologies) described in the datasheet(s) are not to be provided to any party whose purpose in their application will hinder maintenance of international peace and safety nor are they to be applied to that purpose by their direct purchasers or any third party. When exporting these products (technologies), the necessary procedures are to be taken in accordance with related laws and regulations..