

## SPECIFICATION

- Part No. : **MA252.A.LB.001**
- Product Name : Sentinel Adhesive Mount 2in1 GNSS & LTE Antenna
- Feature : Ideal for IoT and Automotive Applications  
Small Size, High Performance  
1\*LTE (2G/3G/4G) Antenna  
1\*GPS-GLONASS-BeiDou Active Antenna  
IP67 Waterproof  
High Efficiency  
Low Profile Housing – Only 14mm in Height  
2M CFD-200 and RG-174 Cables  
SMA(M) Connectors  
Dims: 139\*76\*14mm  
**RoHS Compliant**





## 1. Introduction

The MA252 Sentinel 2in1 LTE and GPS/GLONASS/BeiDou L1 Antenna is an omnidirectional, fully IP67 waterproof external M2M antenna for use in telematics, transportation and remote monitoring applications worldwide. It is designed to be mounted directly on glass or plastic in the interior of vehicles.

It is the smallest high performance solution in the market, 50% smaller than the previous generation, with higher efficiency and wider bandwidth to cover emerging LTE bands. Its performance is comparable with much larger permanent roof mount antennas and now offers a convenient and economical alternative in-cabin mounting solution.

Typical applications include;

- HD video over LTE
- First Responder and Emergency Services
- Automotive vehicle tracking
- Telematics

It is mounted via high quality, first tier automotive approved, 3M adhesive.

In-house world leading dielectric ceramic antenna technology inside allows for smaller size antennas without loss in efficiency. It delivers powerful performance for worldwide 4G LTE bands at 700MHz/800MHz/1700MHz/1800MHz/2600MHz, plus GPS-GLONASS-BeiDou for next generation location accuracy.

4G wireless applications demand high speed data uplink and downlink. High efficiency is necessary to achieve the required signal to noise ratio and throughput required to solve these challenges. Taoglas also takes care to have high isolation between the two MIMO antennas to prevent self-interference. Low loss cables are used to keep efficiency high over long cable lengths.



The IP67 waterproof housing measures just 139\*76\*14mm with 3M foam adhesive. The antenna can be mounted internally or externally on a vehicle. The LTE coaxial cable is 2m low loss CFD-200 with SMA(M) connectors. The GPS-GLONASS-BeiDou cable is RG-174 with SMA(M) connector.

Customized cable and connector versions are also available. The antenna also comes in a 3in1 2\*LTE MIMO and GNSS or a single LTE only variant. Contact your regional Taoglas sales office for support.

## 2. Specification Table

4G/3G/2G Antenna								
Frequency (MHz)		LTE700	GSM850	GSM900	DCS	PCS	UMTS1	LTE2600
		698~803	824~894	880~960	1710~1880	1850~1990	1920~2170	2490~2690
Efficiency (%)								
In free space	30cm	41.77	58.99	60.75	66.44	76.05	66.91	56.87
	1M	39.89	56.33	58.01	60.59	69.53	61.59	51.86
	2M	37.22	52.23	52.91	54.49	61.97	54.72	44.70
	3M	34.74	48.42	49.06	48.24	54.54	47.85	37.97
	5M	29.75	40.81	41.20	37.70	42.12	37.06	29.04
On 2mm ABS base	30cm	41.14	54.04	57.58	66.82	76.00	66.82	55.38
	1M	39.29	51.61	54.99	60.94	69.48	61.51	50.51
	2M	36.67	47.83	50.15	54.81	61.93	54.64	43.54
	3M	34.22	44.34	46.52	48.52	54.49	47.79	36.98
	5M	29.32	37.37	39.06	37.92	42.08	37.01	28.29
On glass base	30cm	43.33	55.50	58.33	63.40	63.83	55.87	56.49
	1M	41.38	53.00	55.71	57.82	58.35	51.42	51.52
	2M	38.62	49.13	50.81	52.03	52.01	45.69	44.42
	3M	36.04	45.54	47.12	46.04	45.77	39.95	37.74
	5M	30.91	38.38	39.57	36.00	35.35	30.95	28.86
Average Gain (dBi)								
In free space	30cm	-3.87	-2.29	-2.17	-1.81	-1.19	-1.81	-2.48
	1M	-4.07	-2.49	-2.37	-2.21	-1.58	-2.17	-2.88
	2M	-4.37	-2.82	-2.77	-2.66	-2.08	-2.68	-3.53
	3M	-4.67	-3.15	-3.10	-3.20	-2.63	-3.27	-4.23
	5M	-5.34	-3.89	-3.85	-4.26	-3.76	-4.37	-5.40
On 2mm ABS base	30cm	-3.89	-2.68	-2.41	-1.78	-1.19	-1.83	-2.60
	1M	-4.09	-2.88	-2.61	-2.18	-1.58	-2.18	-3.00
	2M	-4.39	-3.21	-3.01	-2.64	-2.08	-2.70	-3.64
	3M	-4.69	-3.54	-3.33	-3.17	-2.64	-3.28	-4.35
	5M	-5.36	-4.28	-4.09	-4.24	-3.76	-4.39	-5.51
On glass base	30cm	-3.65	-2.56	-2.34	-1.99	-1.95	-2.60	-2.50
	1M	-3.85	-2.76	-2.54	-2.39	-2.34	-2.95	-2.90
	2M	-4.15	-3.09	-2.94	-2.84	-2.84	-3.47	-3.54
	3M	-4.45	-3.42	-3.27	-3.38	-3.40	-4.05	-4.25
	5M	-5.12	-4.16	-4.03	-4.44	-4.52	-5.16	-5.41

4G/3G/2G Antenna								
Frequency (MHz)	LTE700	GSM850	GSM900	DCS	PCS	UMTS1	LTE2600	
	698~803	824~894	880~960	1710~1880	1850~1990	1920~2170	2490~2690	
Peak Gain (dBi)								
In free space	30cm	1.22	1.89	2.73	4.69	4.69	4.27	4.15
	1M	1.02	1.69	2.53	4.29	4.29	3.87	3.75
	2M	0.72	1.29	2.13	3.79	3.79	3.37	3.05
	3M	0.42	0.99	1.73	3.29	3.29	2.87	2.35
	5M	-0.28	0.19	1.03	2.19	2.19	1.67	1.15
On 2mm ABS base	30cm	0.76	1.57	1.79	3.68	3.68	3.22	3.24
	1M	0.56	1.37	1.59	3.28	3.28	2.86	2.84
	2M	0.26	0.97	1.19	2.78	2.78	2.36	2.14
	3M	-0.04	0.67	0.89	2.28	2.28	1.82	1.44
	5M	-0.74	-0.13	0.09	1.18	1.18	0.66	0.24
On glass base	30cm	1.86	1.94	2.06	3.10	2.90	2.90	3.66
	1M	1.66	1.74	1.86	2.70	2.50	2.50	3.26
	2M	1.36	1.44	1.46	2.30	2.00	2.00	2.56
	3M	1.06	1.14	1.06	1.70	1.40	1.40	1.86
	5M	0.46	0.34	0.36	0.70	0.30	0.30	0.75
Impedance				50Ω				
Polarization				Linear				
Return Loss				< -6dB				
Input Power				5W				

BeiDou-GPS-GLONASS	
Center Frequency	BeiDou: 1561.098±2.046MHz GPS: 1575.42±1.023MHz GLONASS: 1602±5MHz
Passive Antenna Efficiency (without cable loss)	BeiDou: 62.2% GPS: 65.86% GLONASS: 75.07%
Passive Antenna Average gain(without cable loss)	BeiDou: -2.03 GPS: -1.81 GLONASS: -1.25
Passive Antenna Peak gain(without cable loss)	BeiDou:1.7 GPS:3.03 GLONASS:4.22
VSWR	< 3:1
Impedance	50Ω
Axial Ratio	BeiDou: 8.97 GPS: 12.48 GLONASS: 20.6
Polarization	RHCP

LNA and Filter Electrical Properties				
Center Frequency	BeiDou: 1561.098±2.046MHz GPS: 1575.42±1.023MHz GLONASS: 1602±5MHz			
Output Impedance	50Ω			
VSWR	< 2:1			
Return Loss	< -10dB			
LNA Gain, Current Draw, and Noise Figure @GPS	Voltage	LNA Gain(Typ)	Current Draw (Typ)	Noise Figure(Typ)
	Min 1.8V	25.34	5mA	2.30
	Typ 3.0V	28.63	10mA	2.69
	Max 5.5V	32.79	23mA	2.98
Total specification(Through Antenna, SAW Filter, and LNA)				
Frequency	1561.098±2.046 MHz	1575.42±1.023 MHz	1602±5 MHz	
Gain@3V(dB)	28.06	28.63	27.84	
Output Impedance	50Ω			

MECHANICAL	
Antenna Dimensions	139.27*76.27*14mm
Housing	ABS
Waterproof	IP67
Connector	SMA(M) ST
Cable type	LTE : CFD-200 GPS/GLONASS/BeiDou : RG-174
Cable length	2000mm
Weight	280g
ENVIRONMENTAL	
Operation Temperature	-40°C to 85°C
Storage Temperature	-40°C to 85°C
Humidity	Non-condensing 65°C 95% RH

### 3. Antenna Characteristics

#### 3.1. LTE Characteristics

##### 3.1.1. Test Setup



In free space

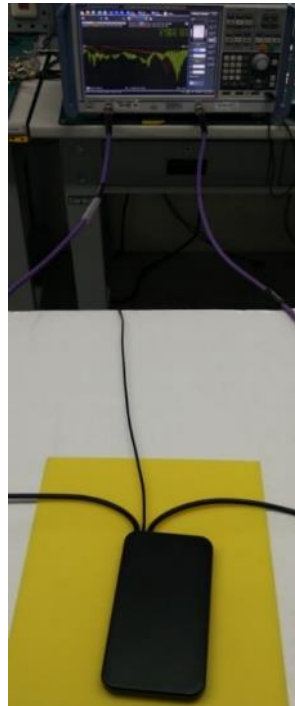

On 2mm ABS

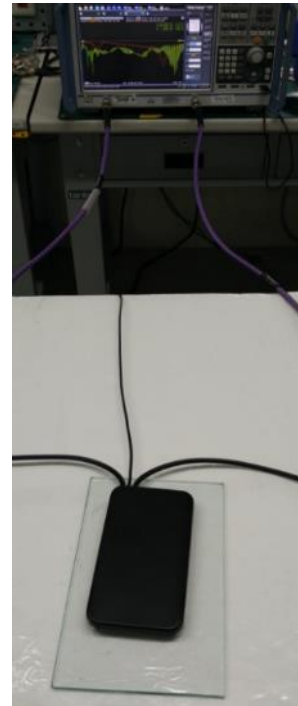

On glass

### 3.1.2. Return Loss

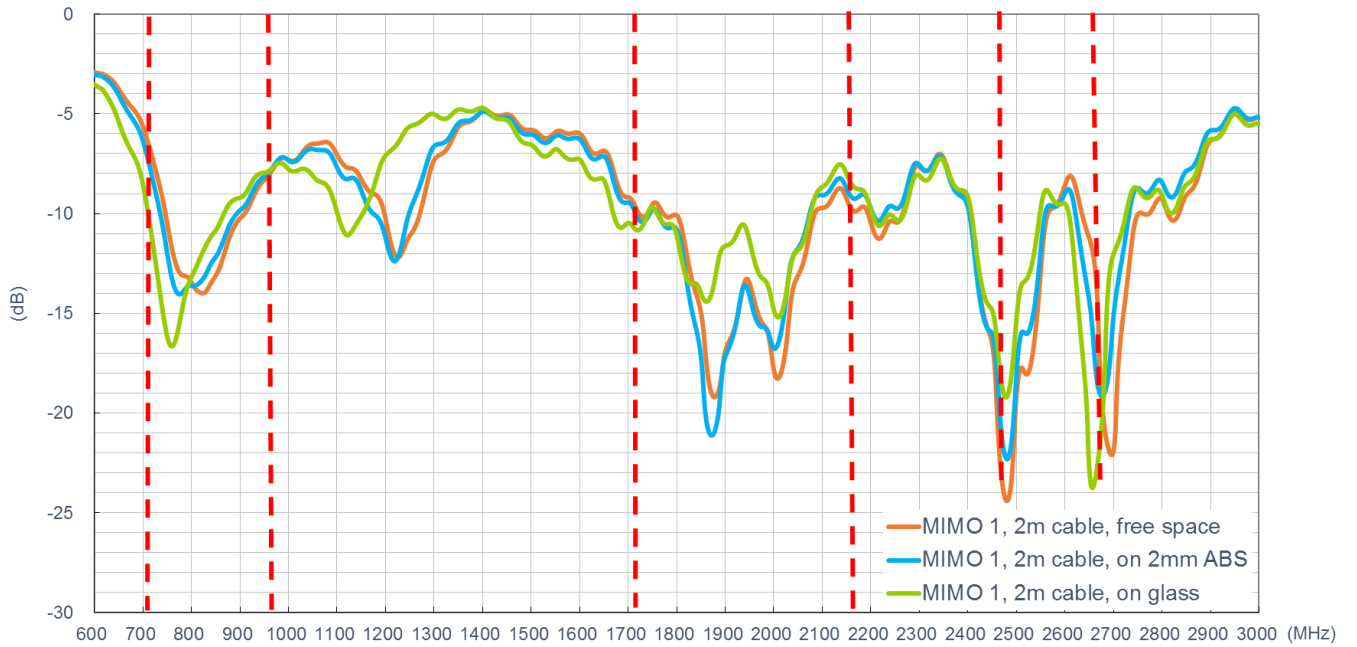

### 3.1.3. Efficiency

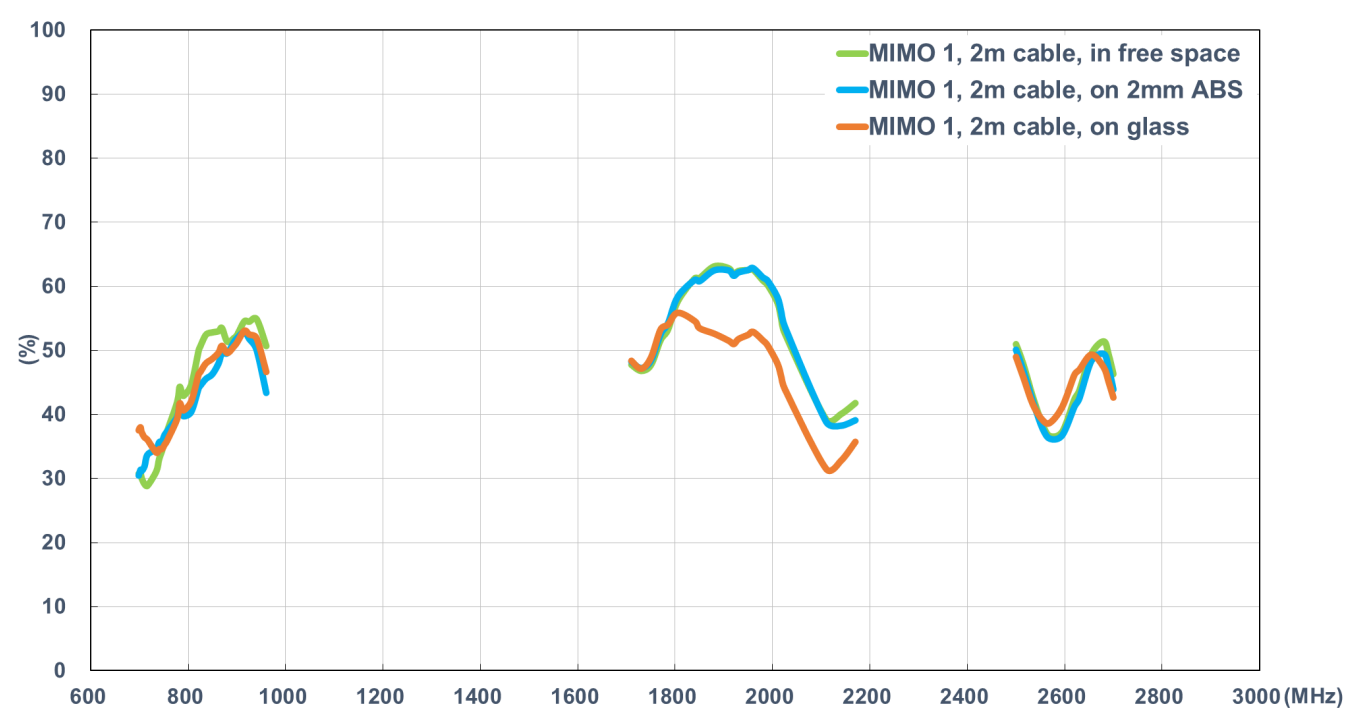



### 3.1.4. Average Gain

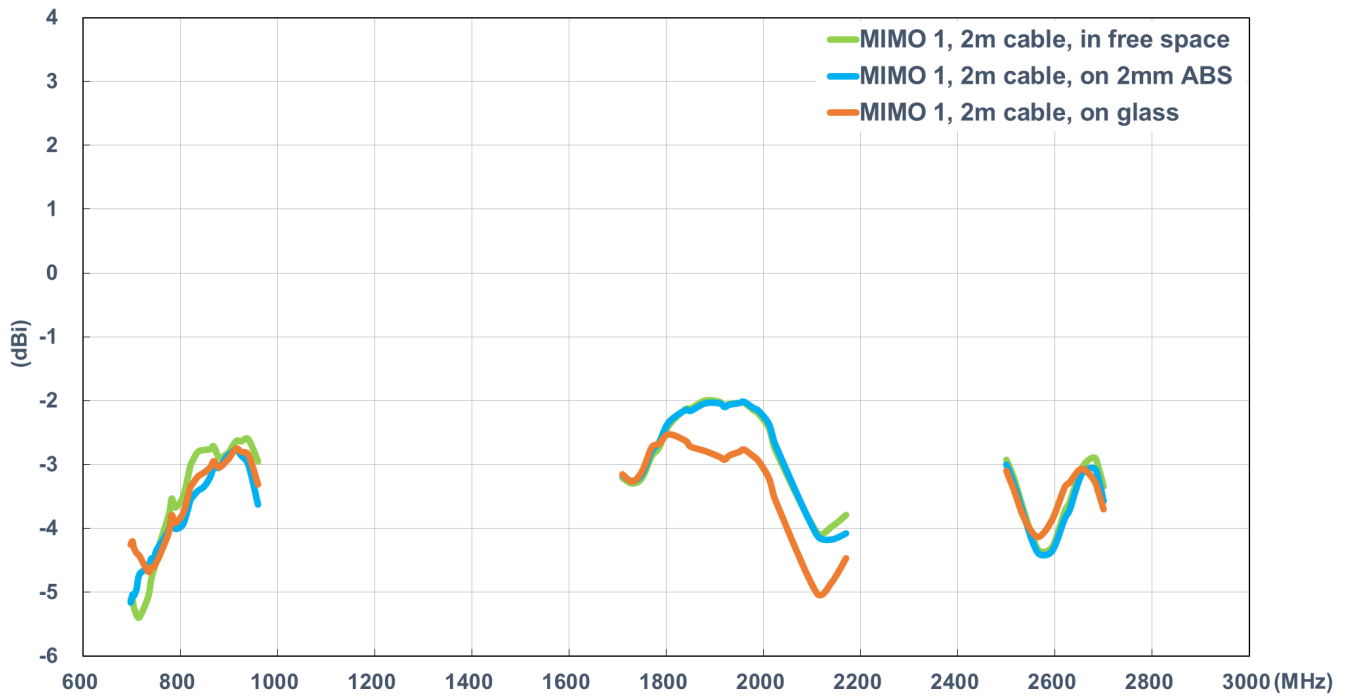

### 3.1.5. Peak Gain

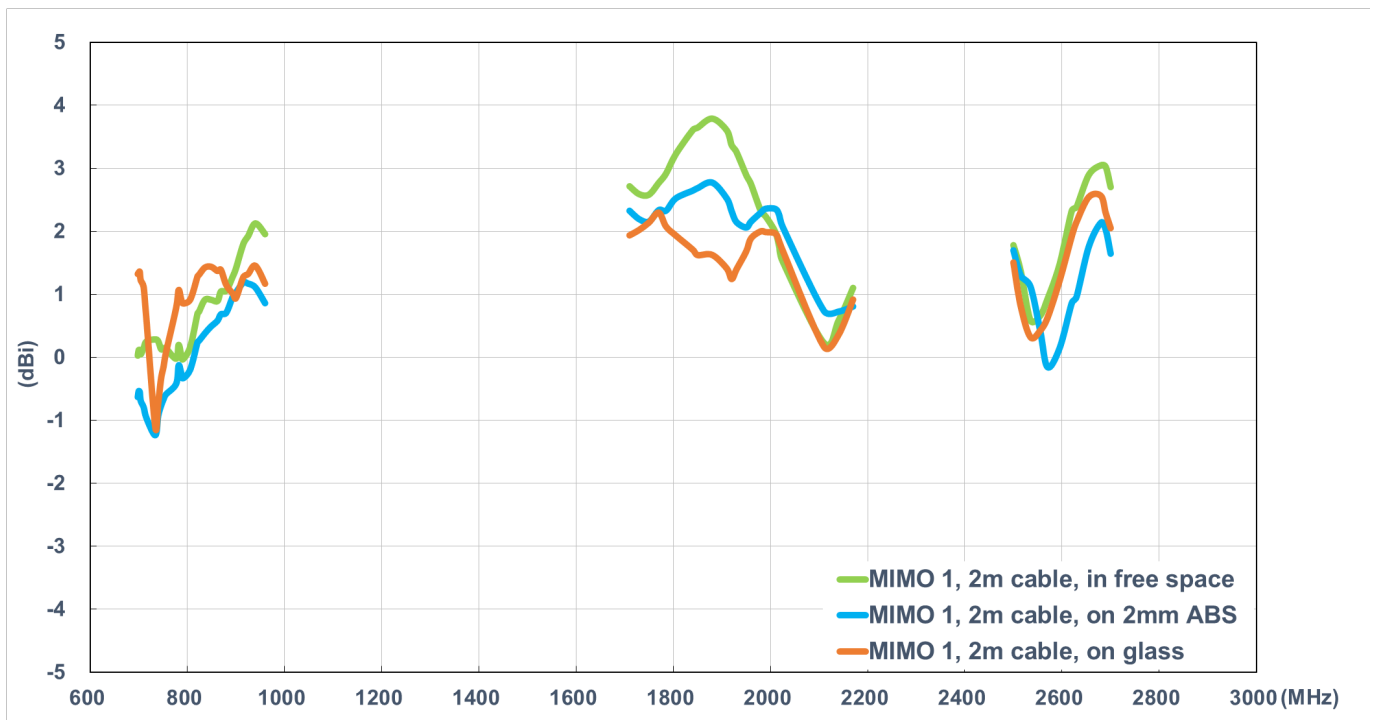

### 3.2. GPS/GLONASS/BeiDou Characteristics

#### 3.2.1. Return Loss

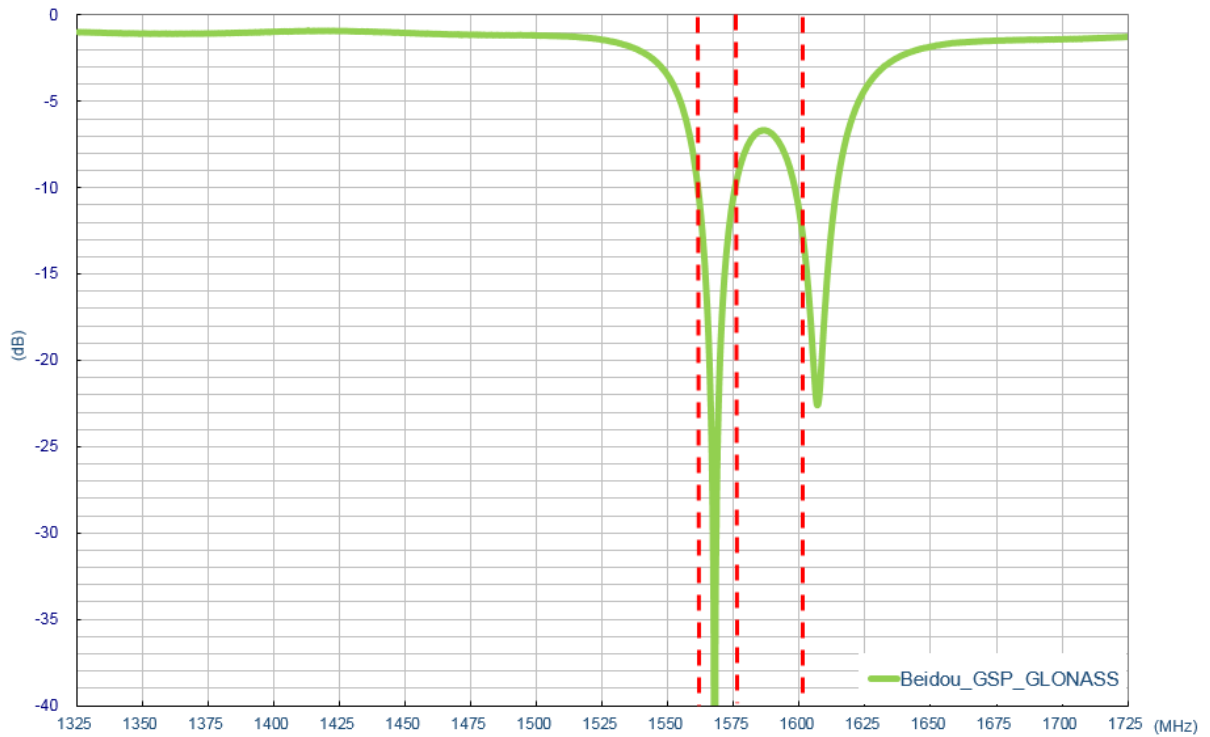

#### 3.2.2. Smith Chart

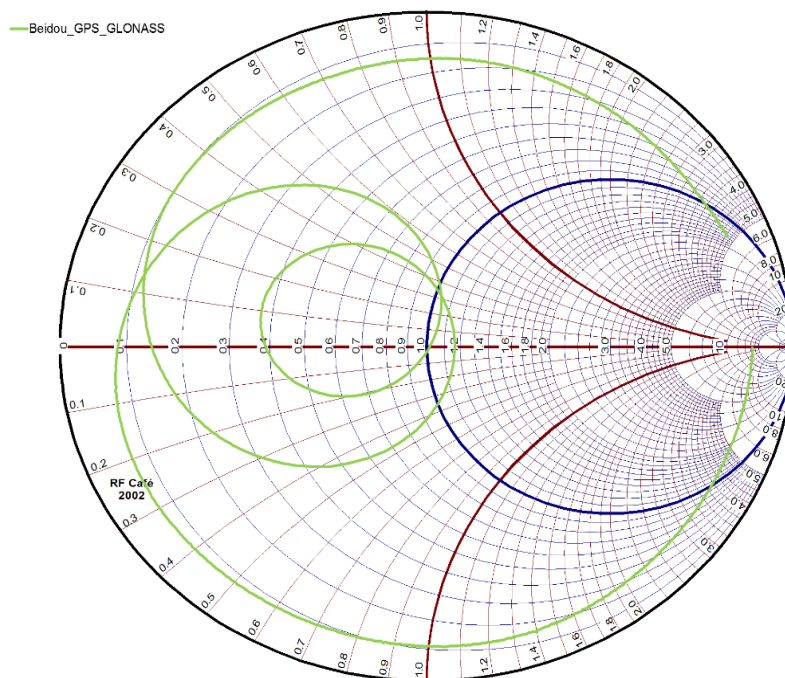

### 3.2.3. Efficiency

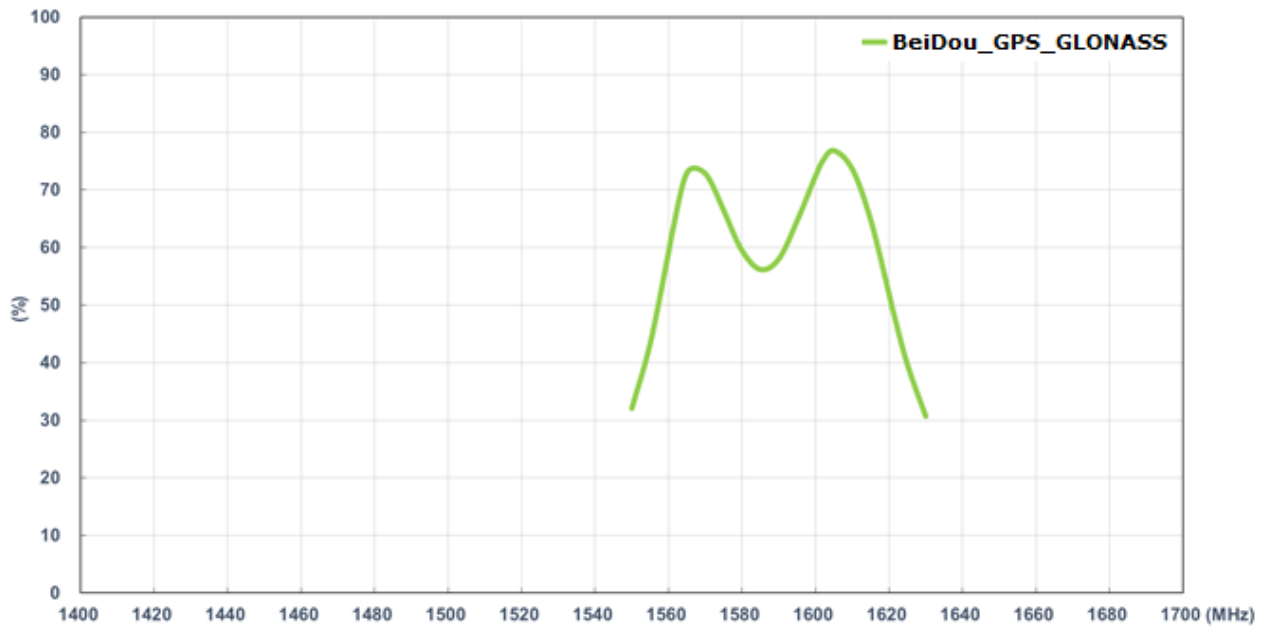

### 3.2.4. Average Gain

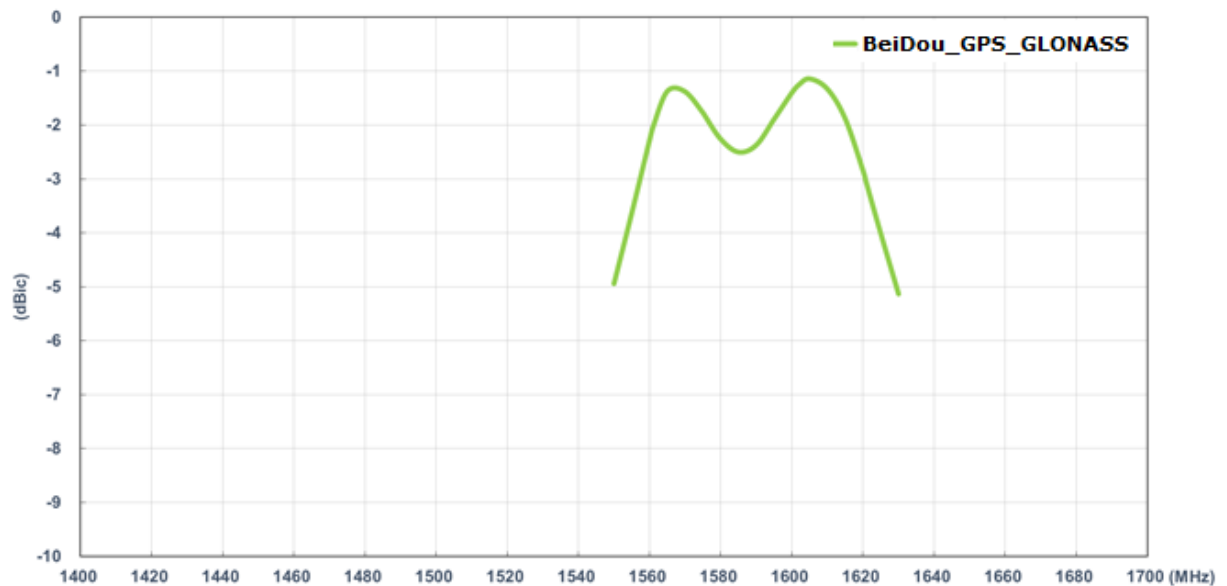

### 3.2.5. Peak Gain

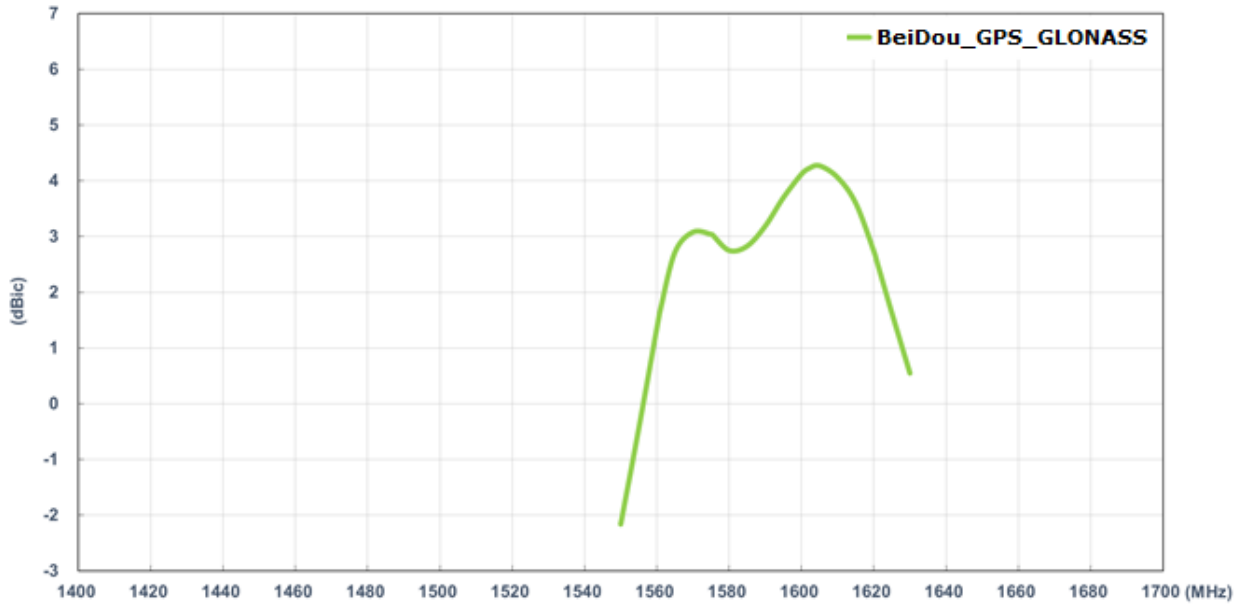

### 3.2.6. Axial Ratio

#### 3.2.6.1. BeiDou

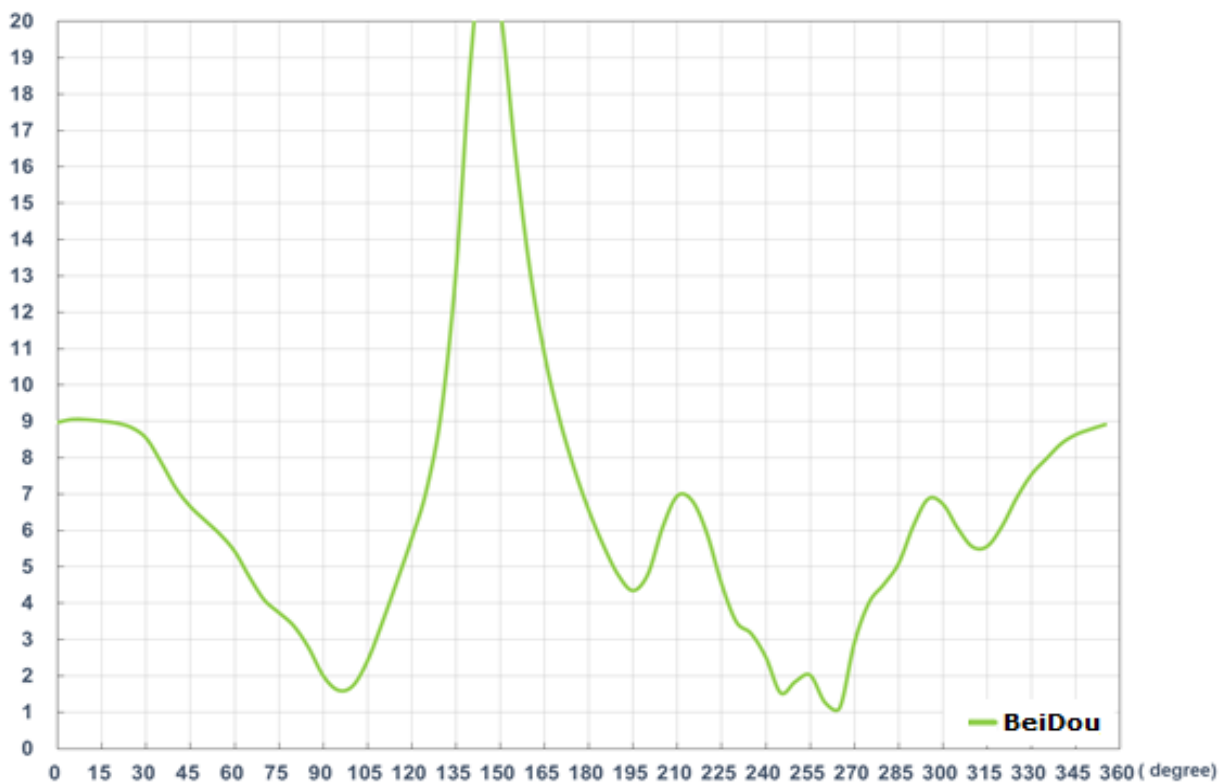

### 3.2.6.2. GPS

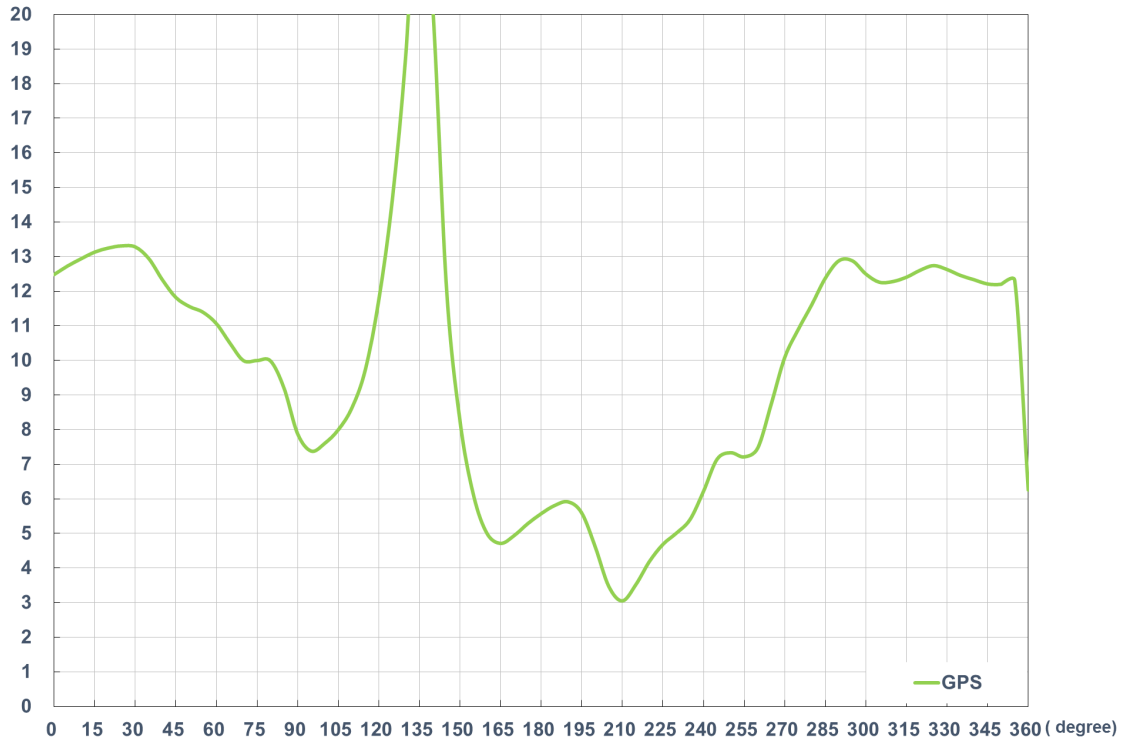

### 3.2.6.3. GLONASS

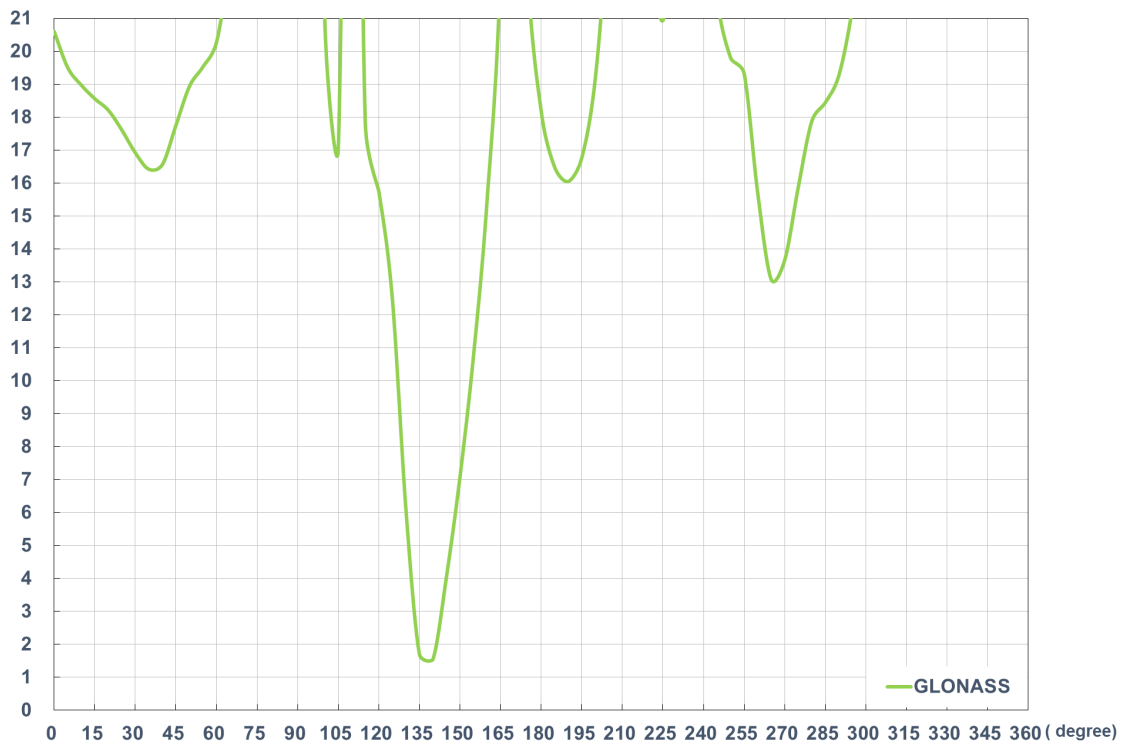

### 3.2.7. LNA Gain and Noise Figure

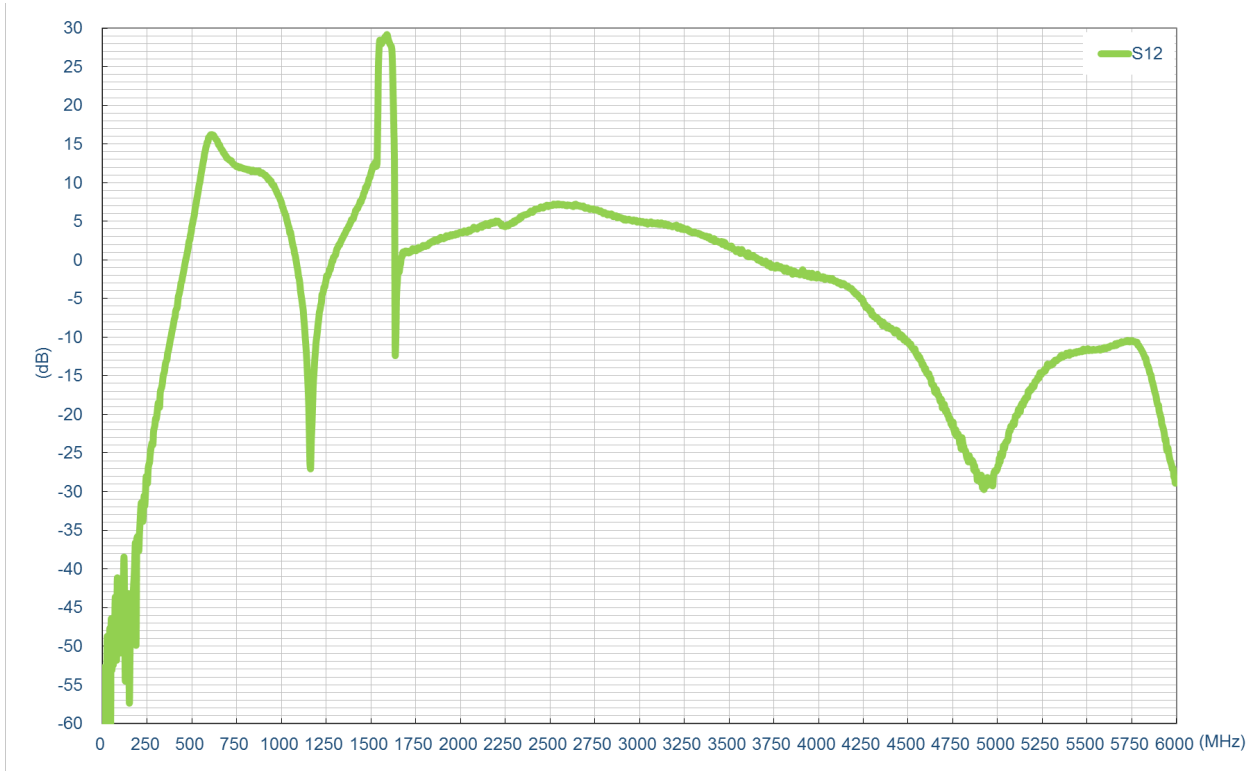

LNA Gain @3.0V

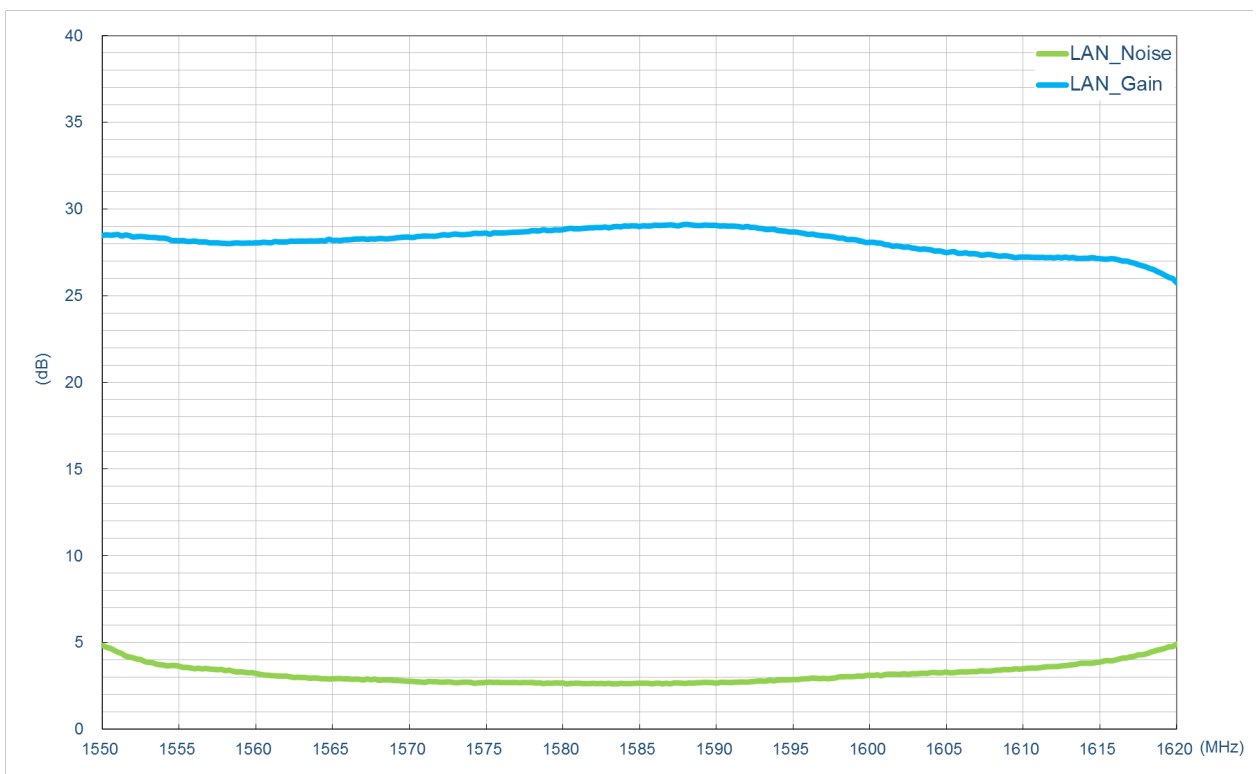

LNA Noise Figure @3.0V

### 3.3. 2D Radiation Pattern

#### 3.3.1. Test Setup

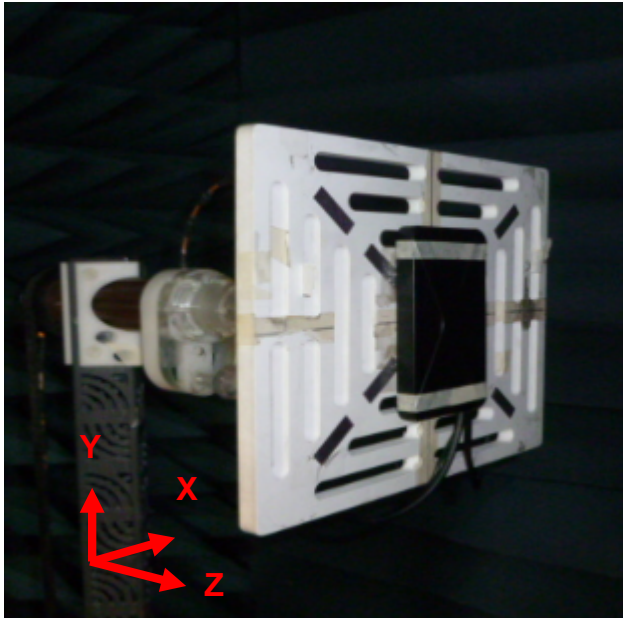

In free space

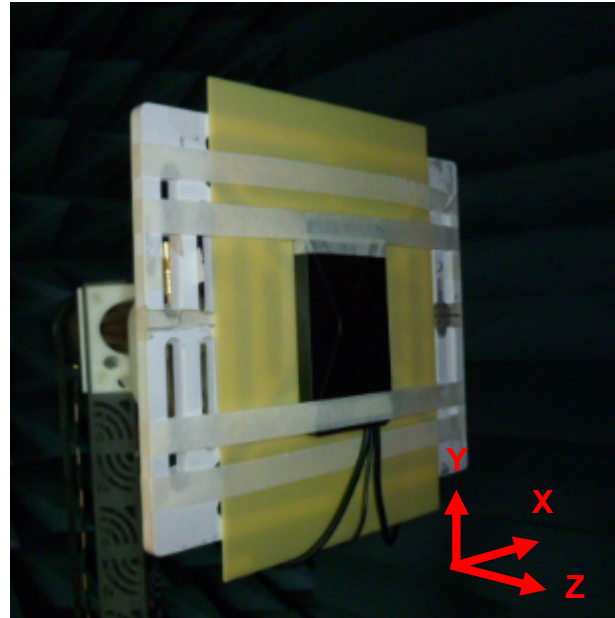

On 2mm ABS

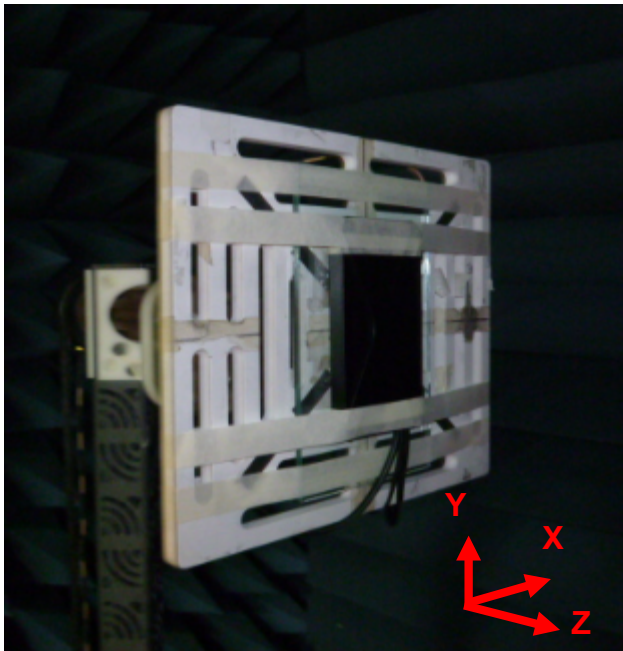

On the glass base

### 3.3.2. LTE with 2M cable length in free space

#### XY Plane

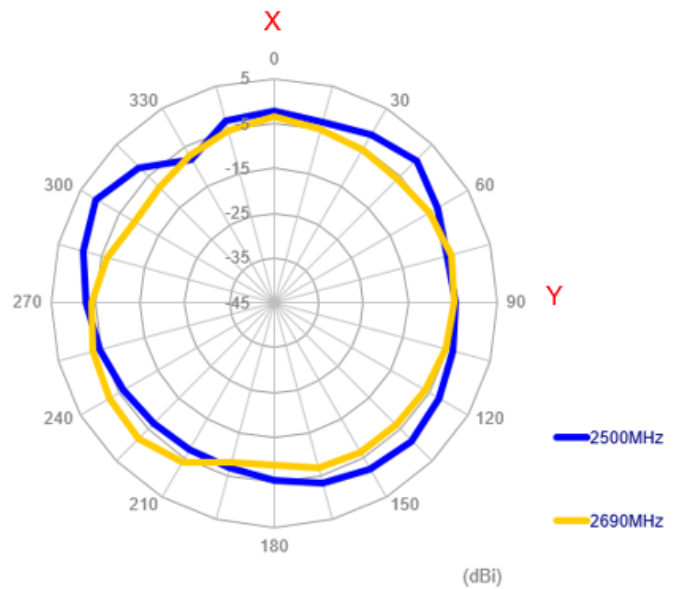
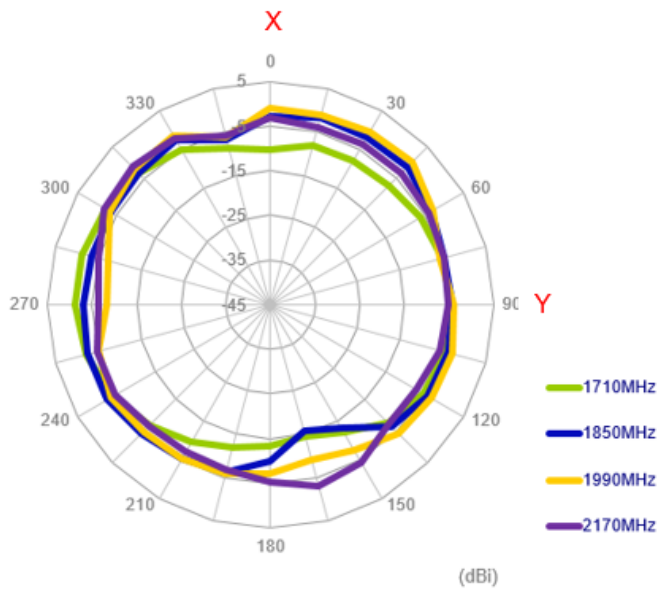
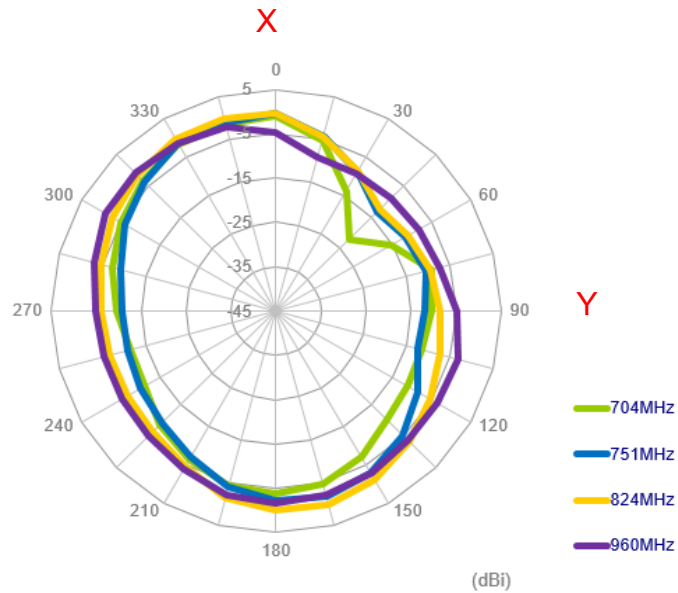



XZ Plane

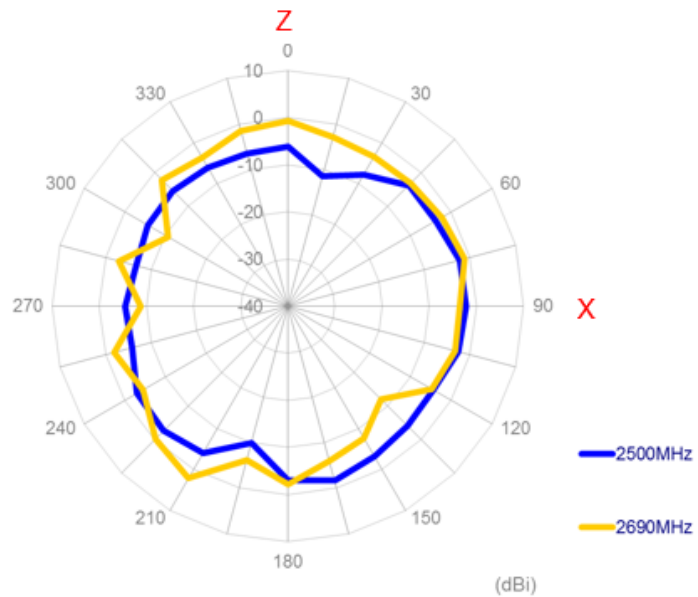
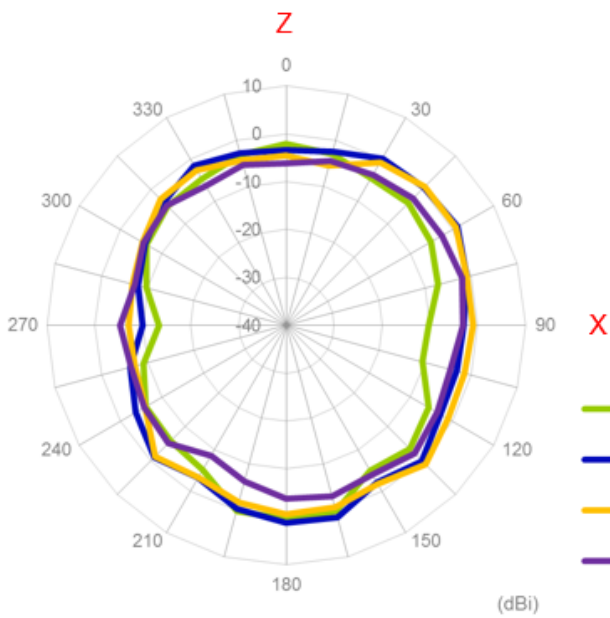
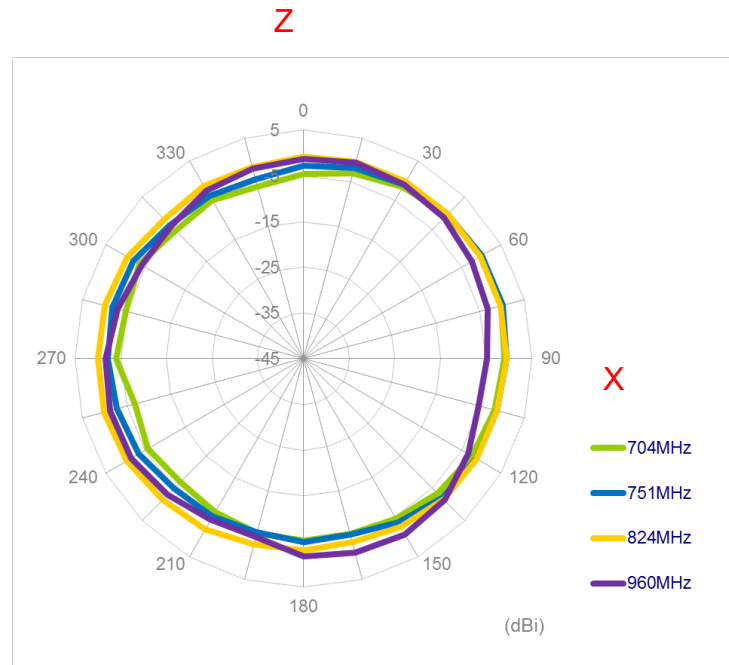

YZ Plane

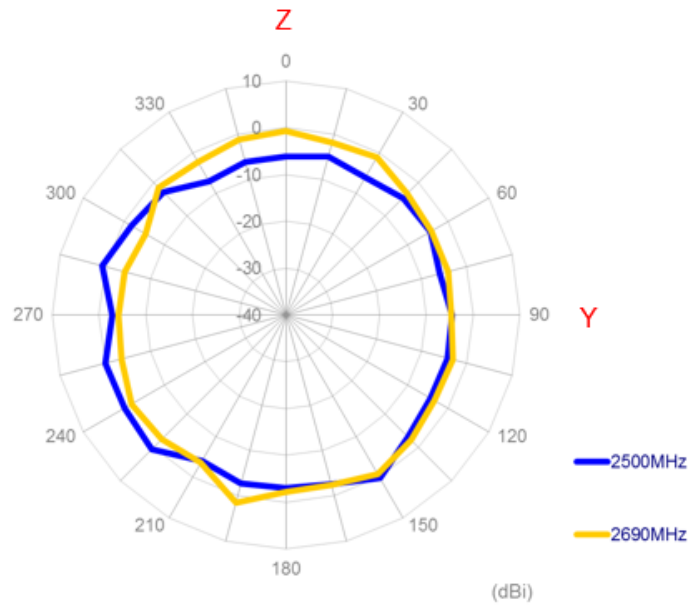
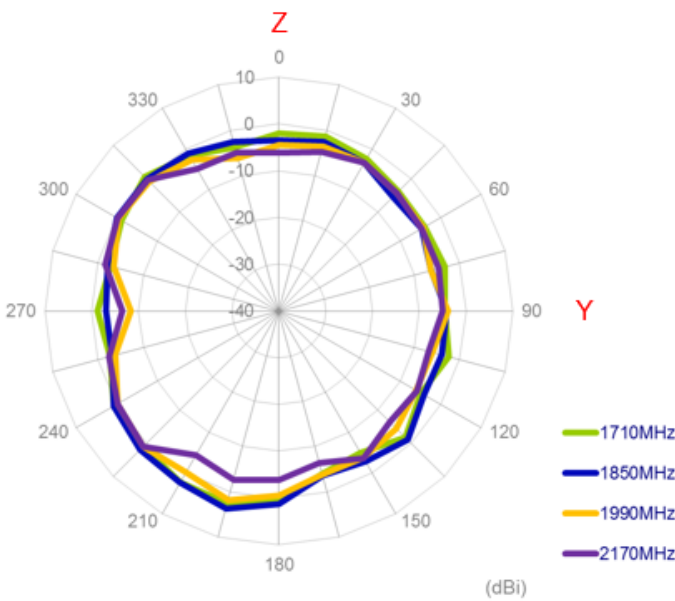
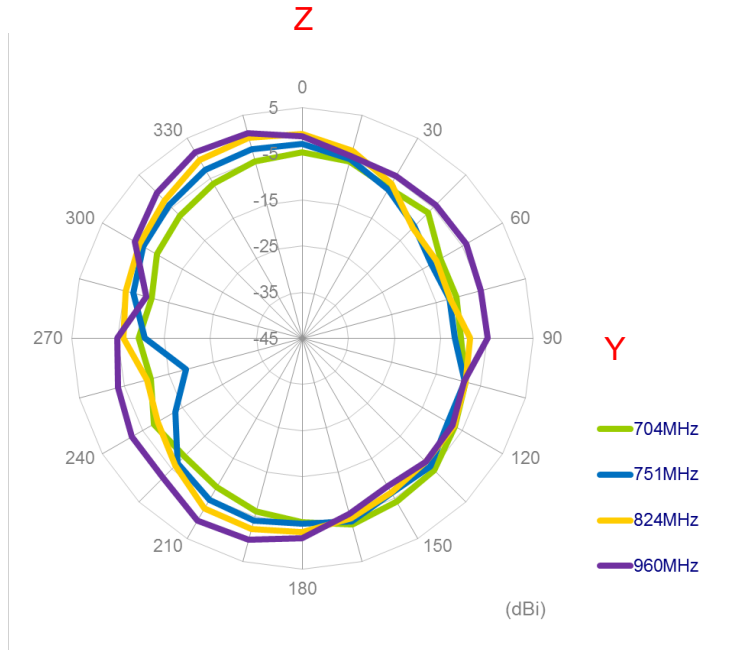

### 3.3.3. LTE with 2M cable length on the 2mm ABS XY Plane

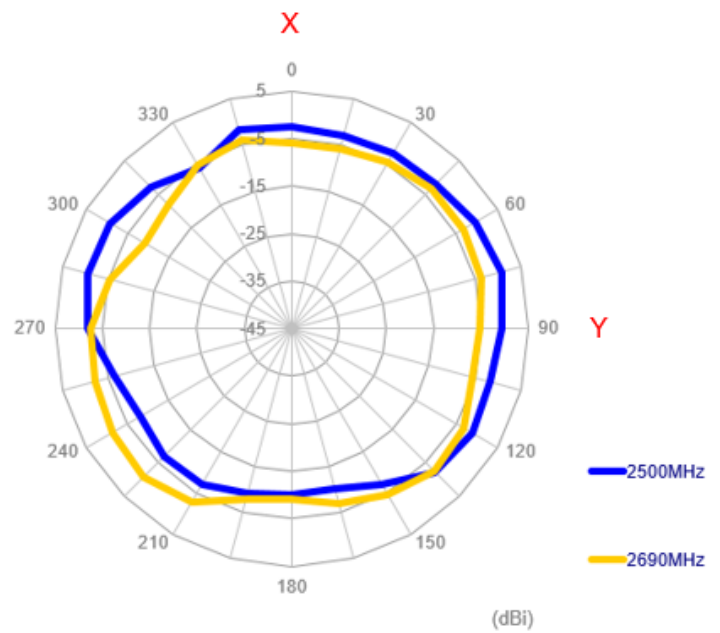
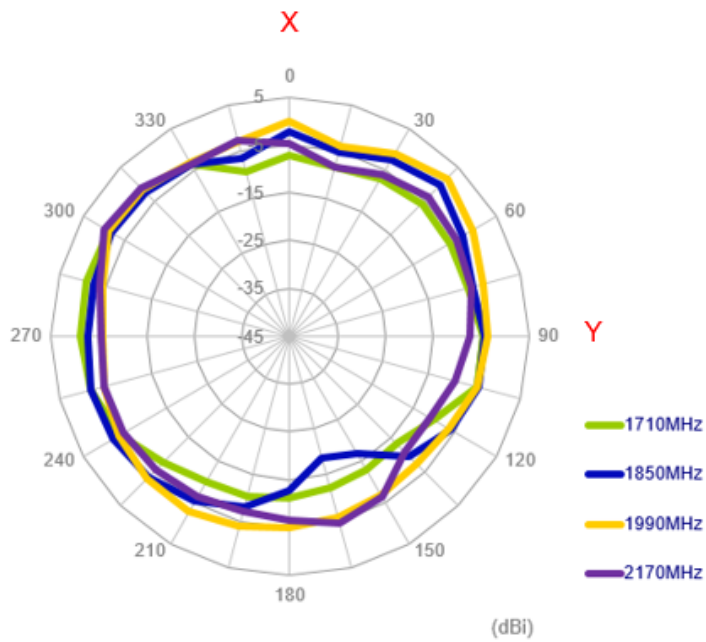
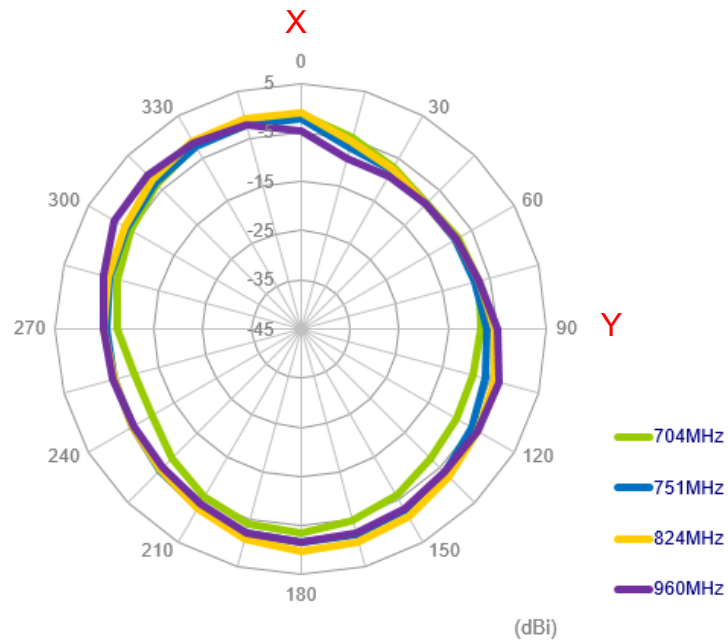



### XZ Plane

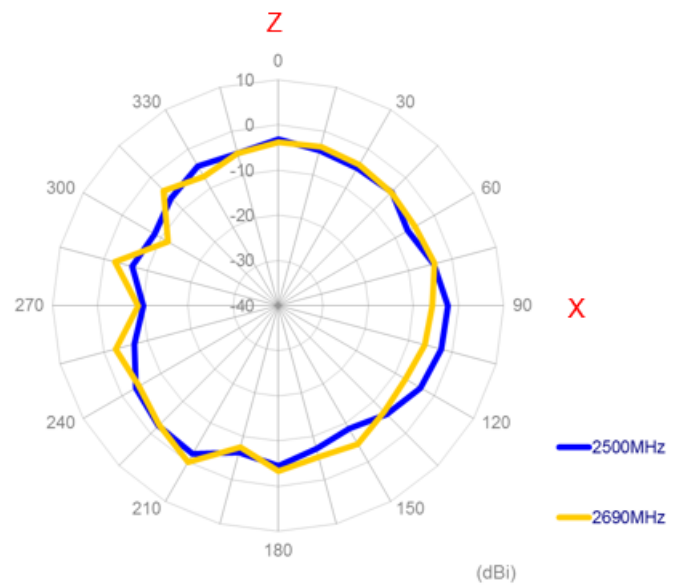
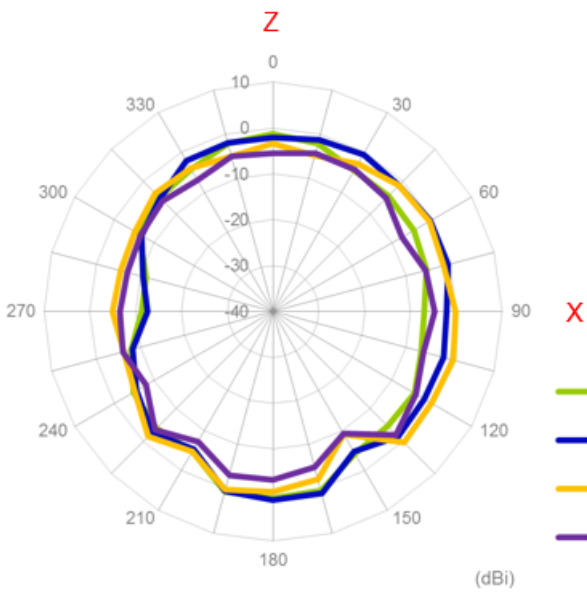
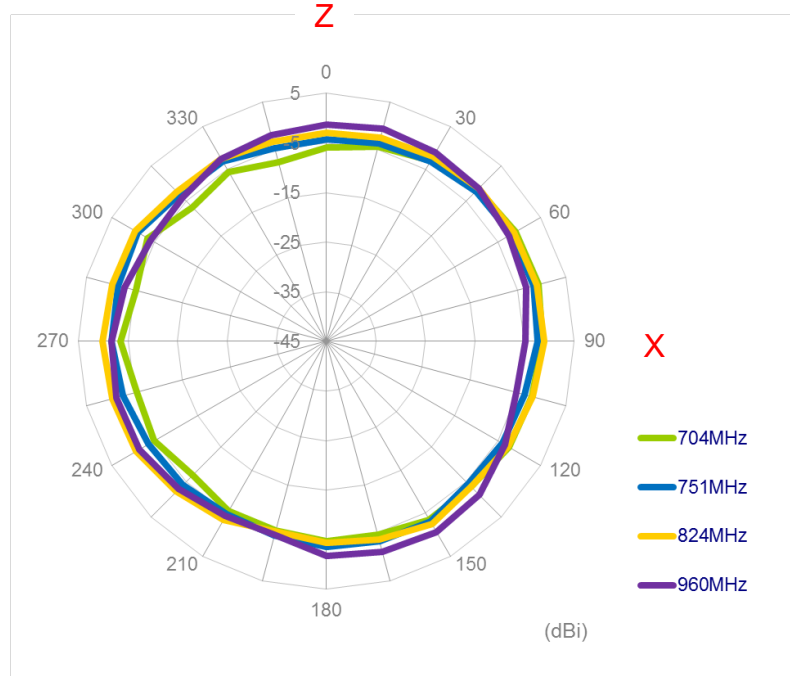

YZ Plane

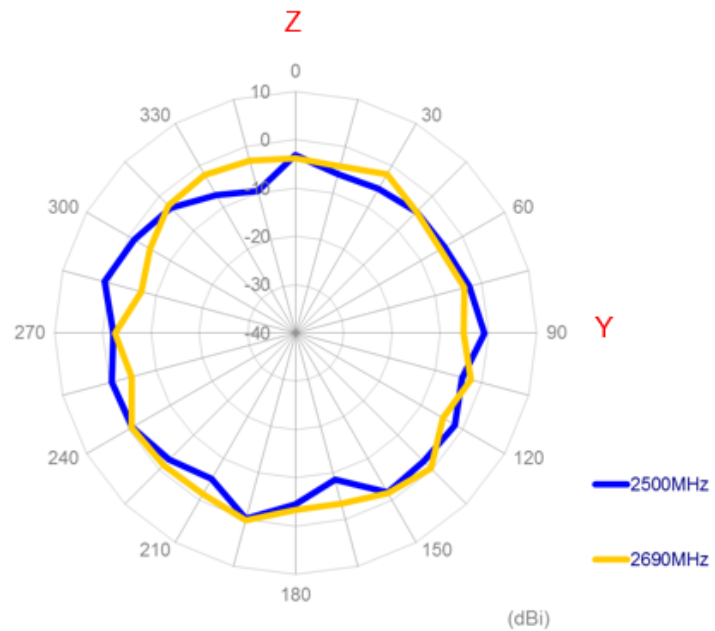
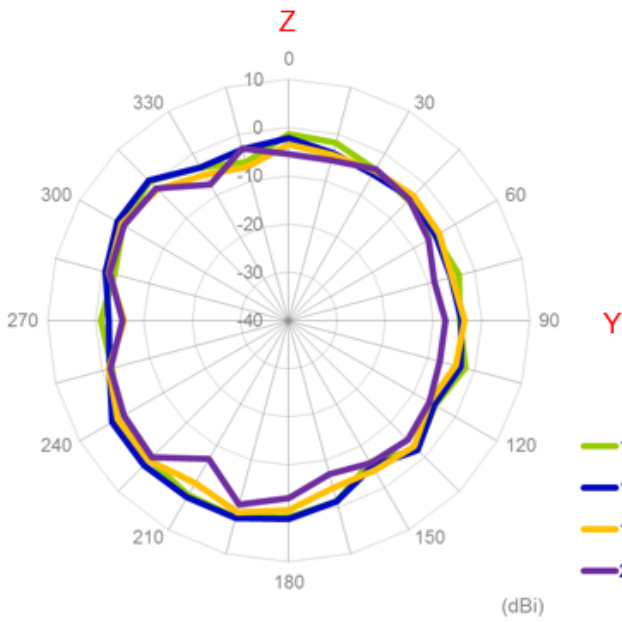
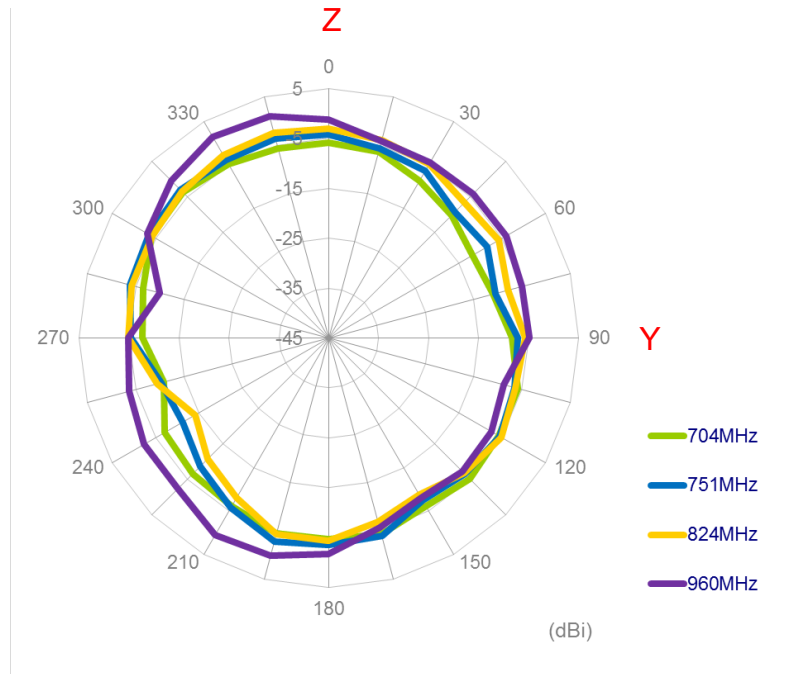

### 3.3.4. LTE with 2M cable length on the glass

#### XY Plane

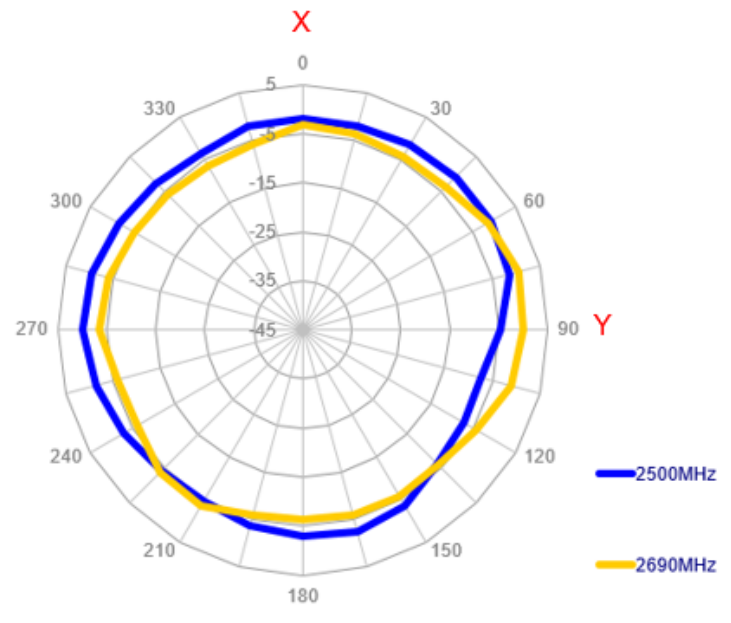
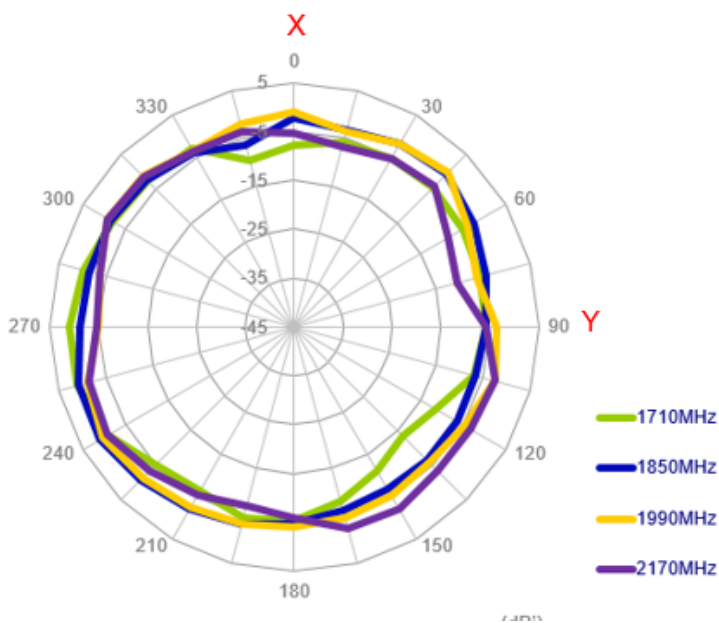
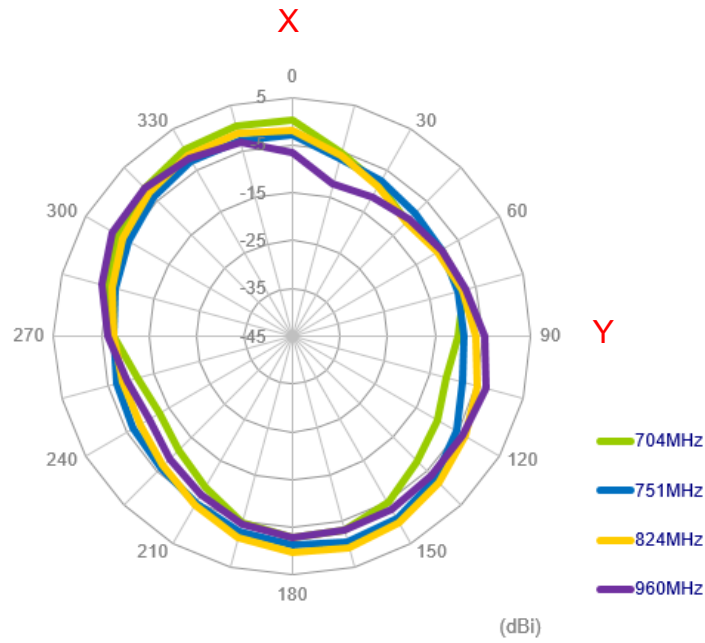

XZ Plane

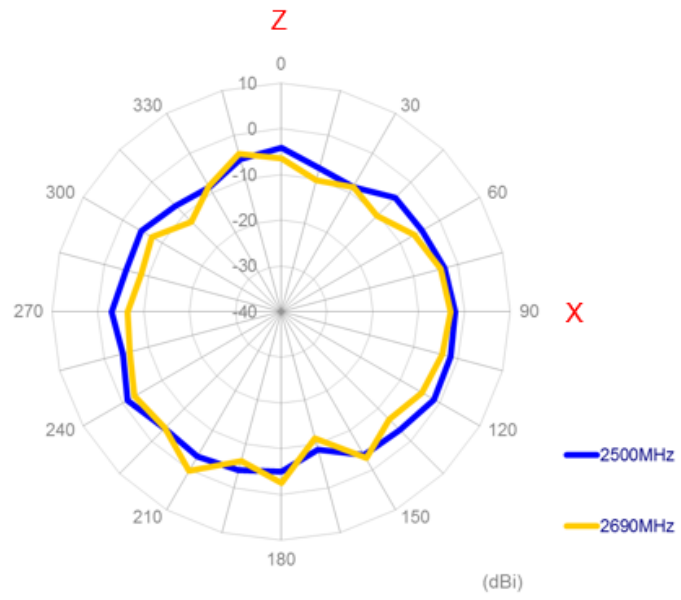
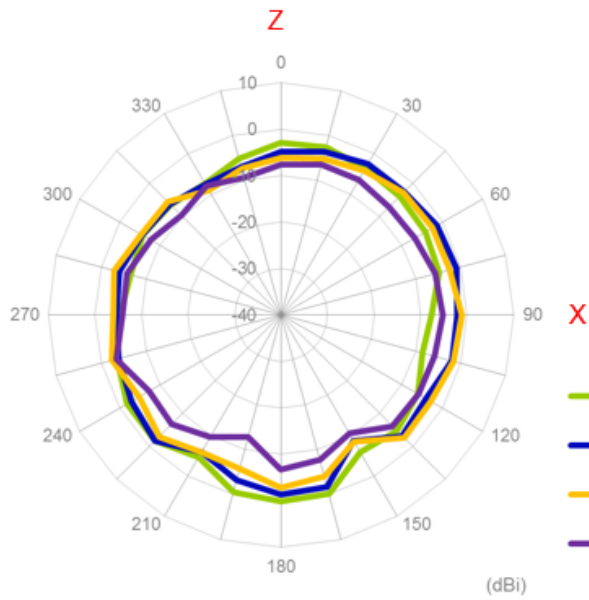
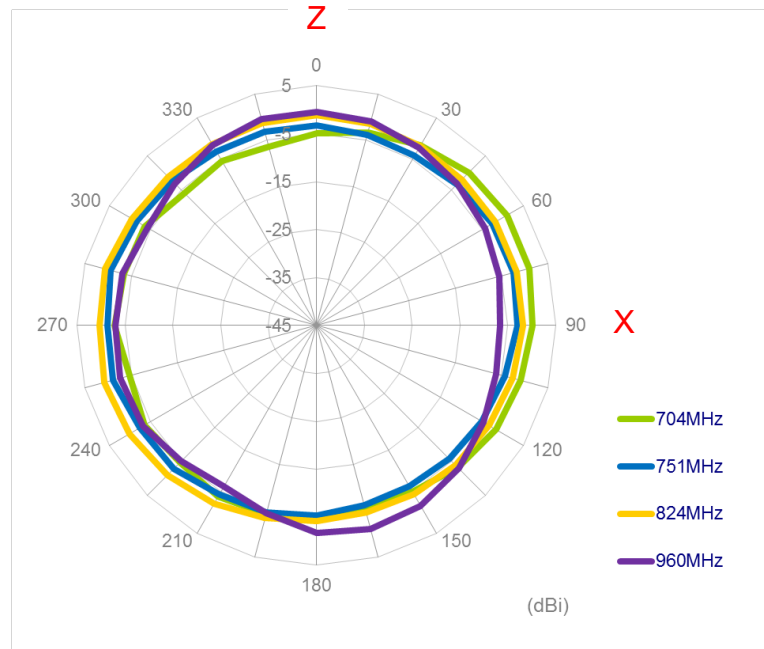

YZ Plane

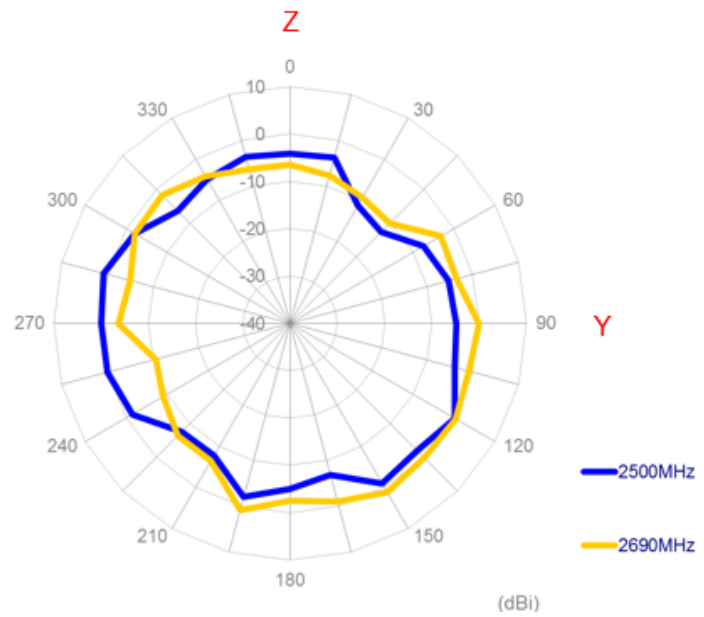
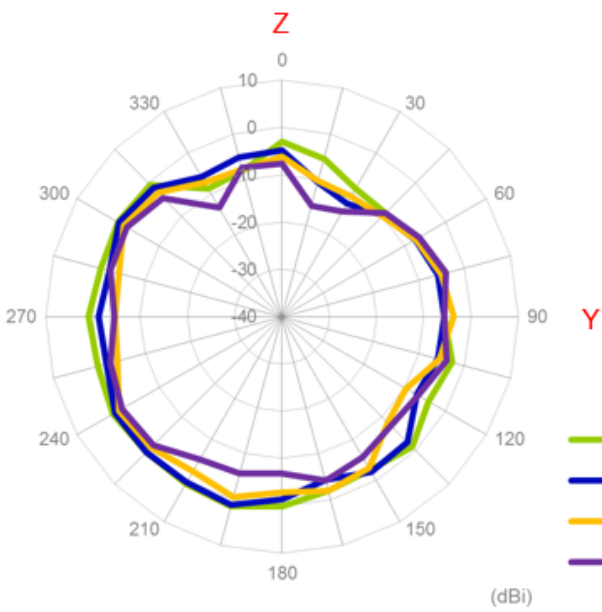
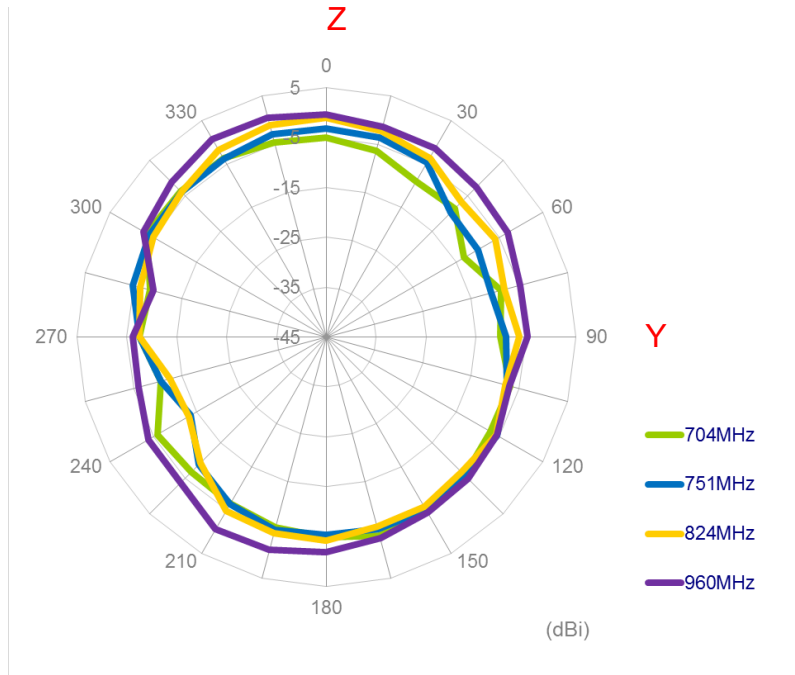



### 3.3.5. GPS/GLONASS/BeiDou

#### XY Plane

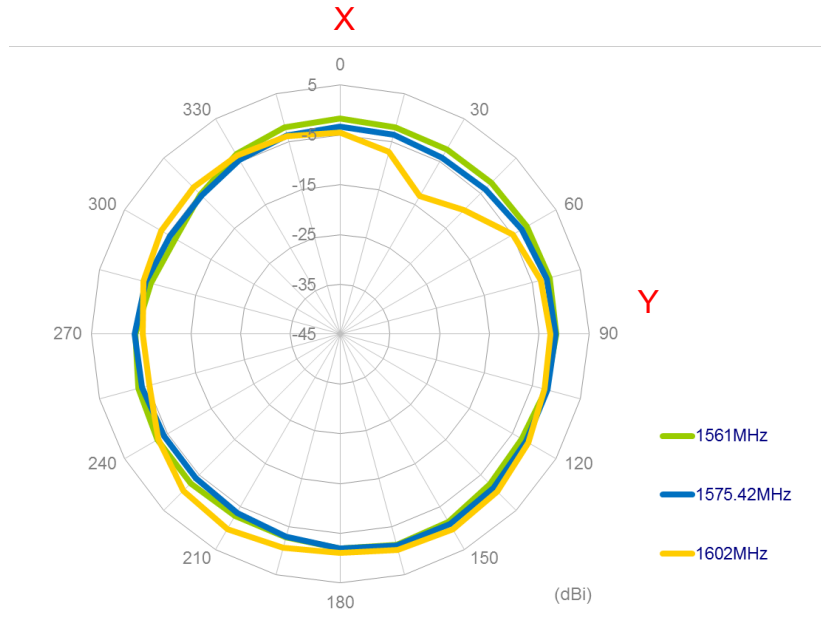

#### XZ Plane

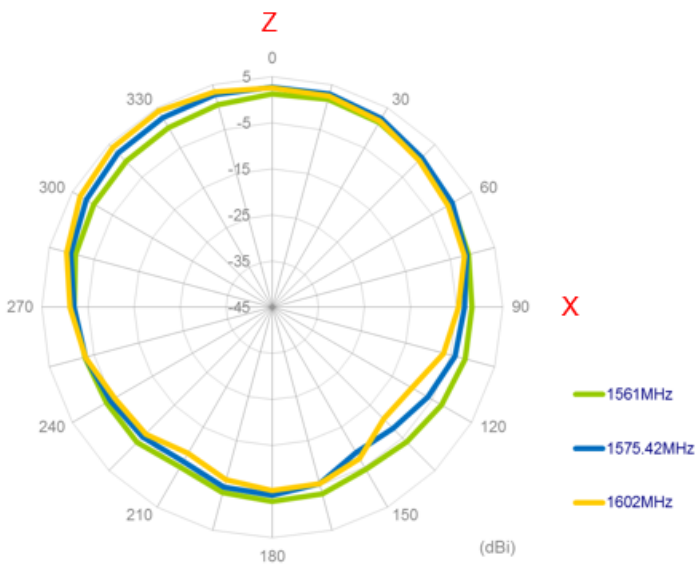

#### YZ Plane

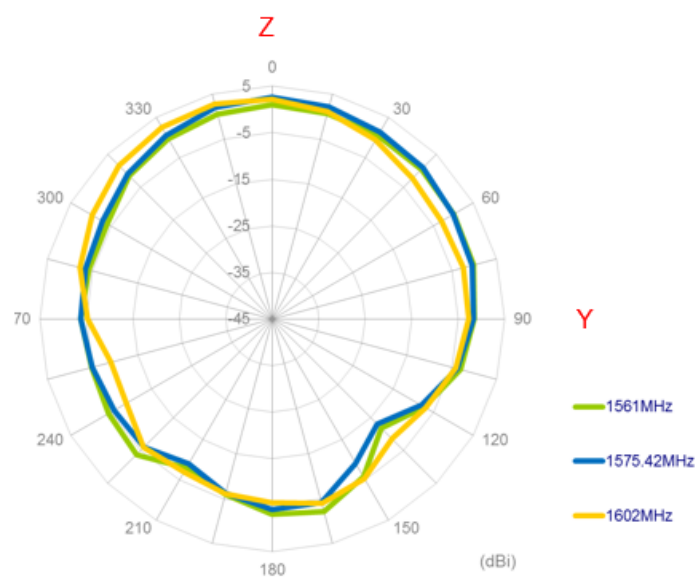

### 3.4. 3D Radiation Pattern

#### 3.4.1. LTE with 2M cable length in free space

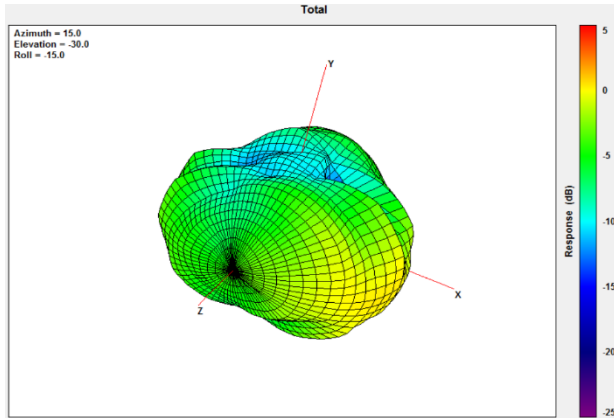

704MHz

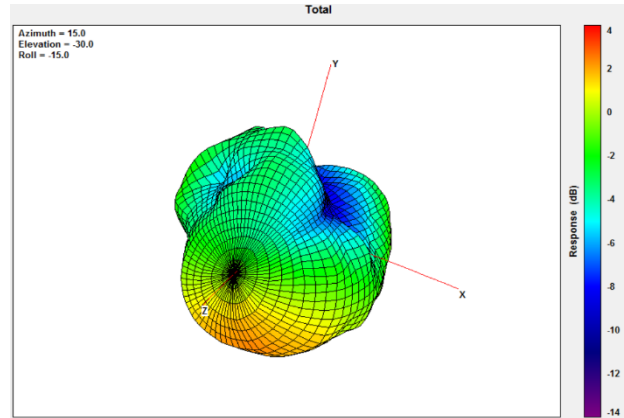

960MHz

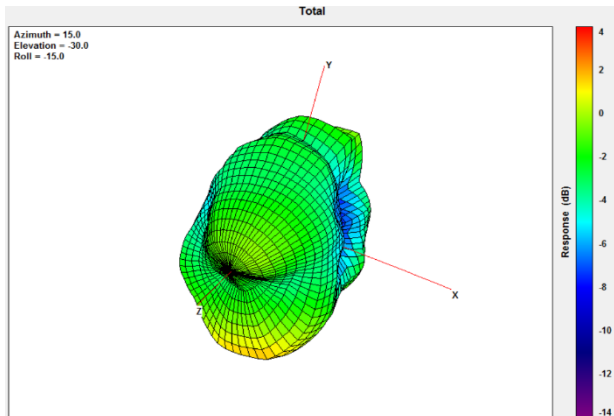

1710MHz

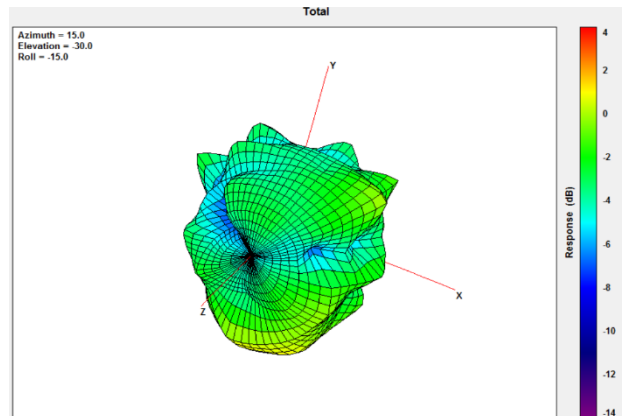

2170MHz

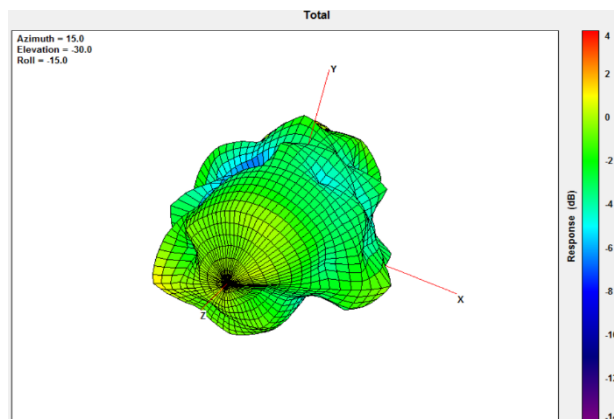

2690MHz

### 3.4.2. LTE with 2M cable length on the 2mm ABS

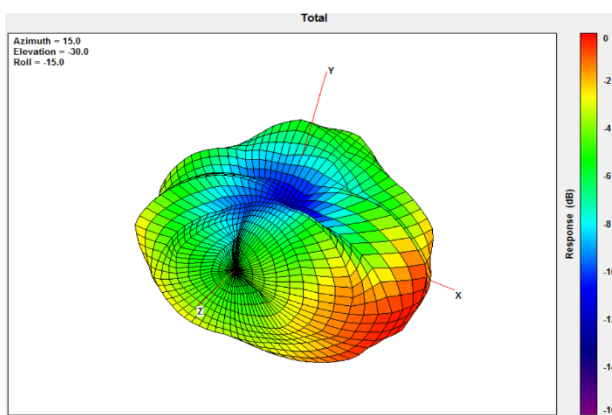

704MHz

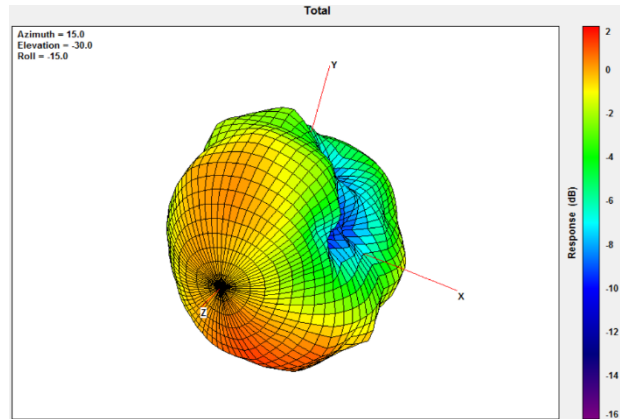

960MHz

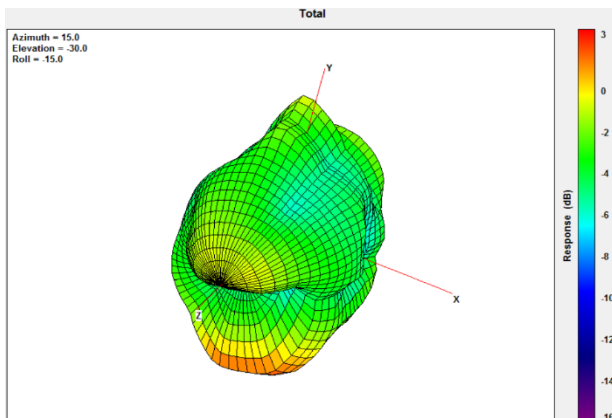

1710MHz

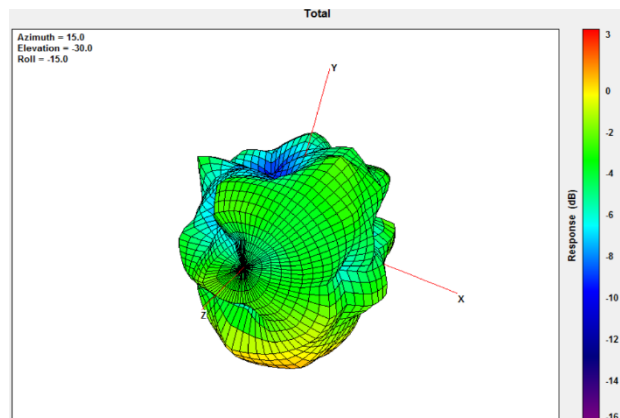

2170MHz

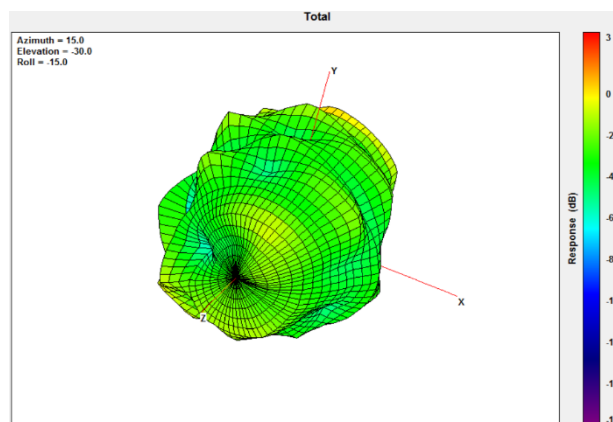

2690MHz

### 3.4.3. LTE with 2M cable length on the glass

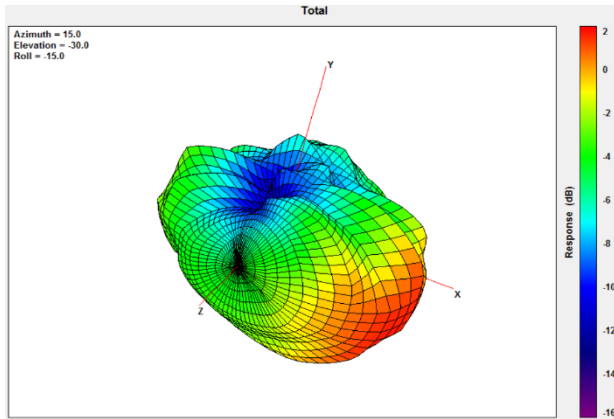

704MHz

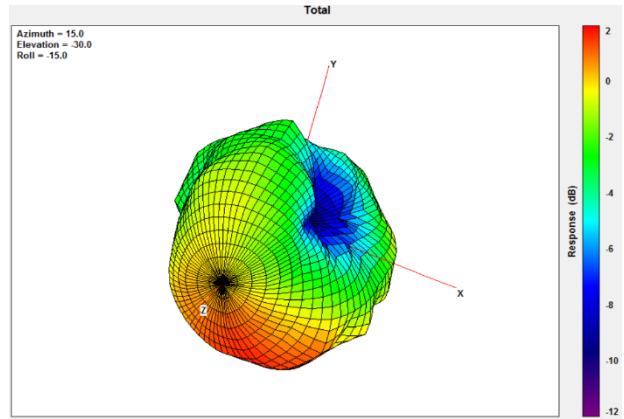

960MHz

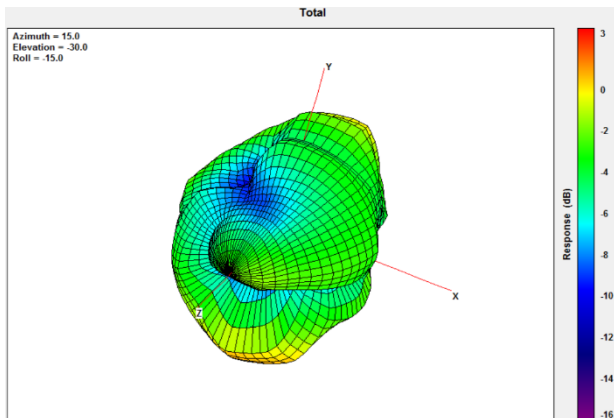

1710MHz

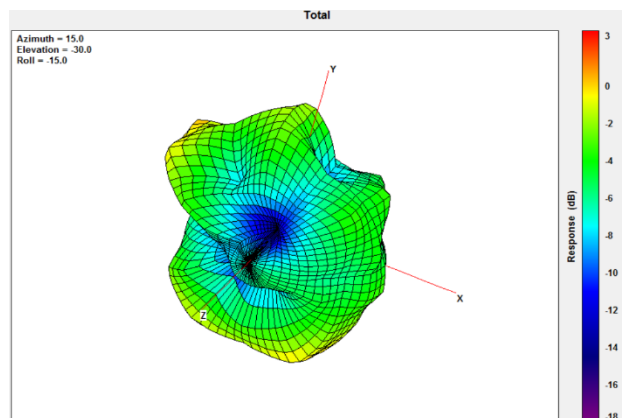

2170MHz

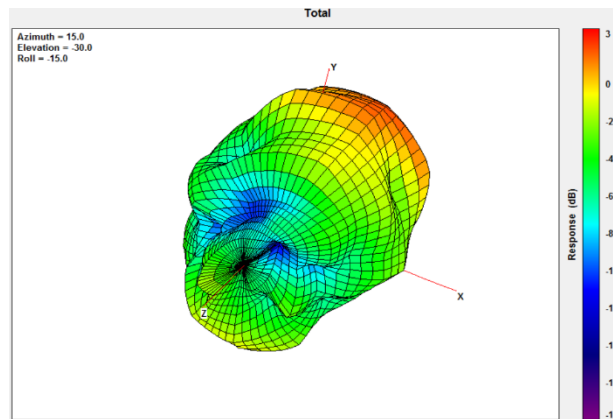

2690MHz

### 3.4.4. GPS/GLONASS/BeiDou

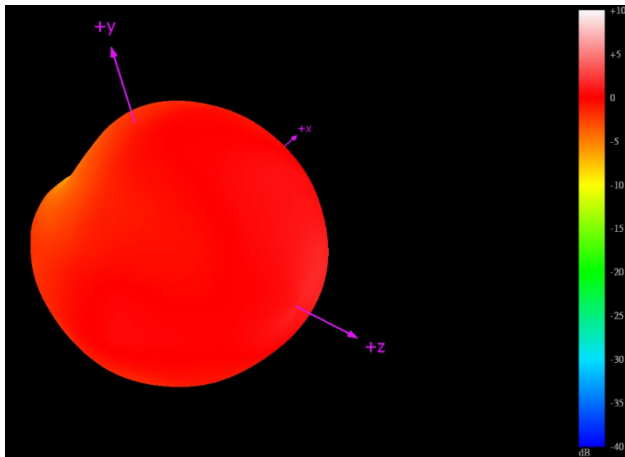

1561MHz

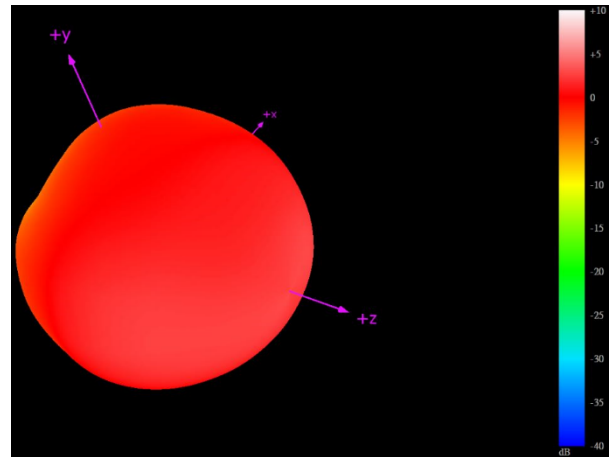

1575.42MHz

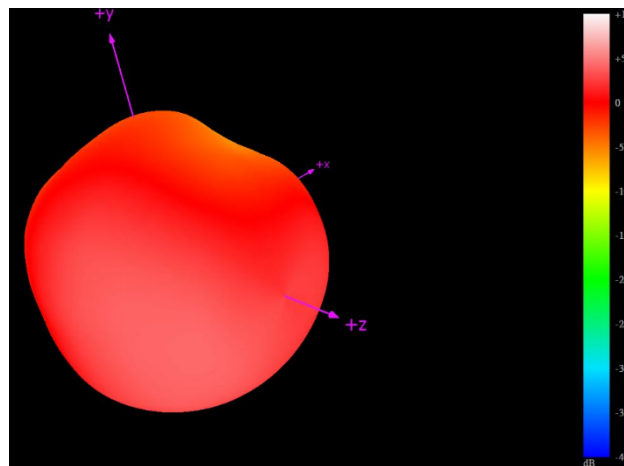

1602MHz

## 4. Drawing

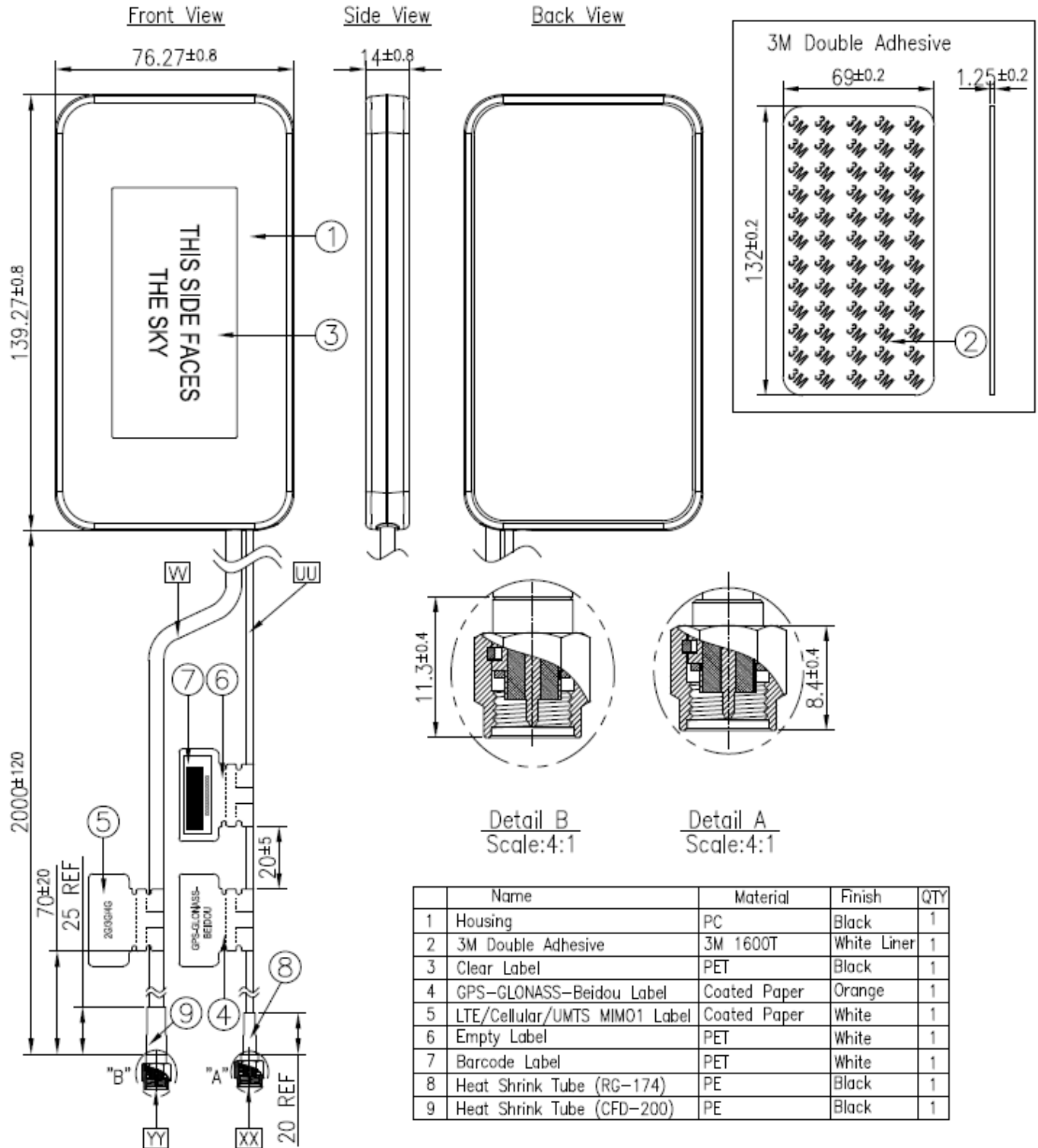

	Name	Material	Finish	QTY
1	Housing	PC	Black	1
2	3M Double Adhesive	3M 1600T	White Liner	1
3	Clear Label	PET	Black	1
4	GPS-GLONASS-Beidou Label	Coated Paper	Orange	1
5	LTE/Cellular/UMTS MIMO1 Label	Coated Paper	White	1
6	Empty Label	PET	White	1
7	Barcode Label	PET	White	1
8	Heat Shrink Tube (RG-174)	PE	Black	1
9	Heat Shrink Tube (CFD-200)	PE	Black	1

	Name	SPEC	Finish	QTY
UU	Cable Type	RG-174	Black	1
W	Cable Type	CFD-200	Black	1
XX	Connector Type	SMA(M)ST	Au Plated	1
YY	Connector Type	SMA(M)ST	Au Plated	1

## 5. Packaging

1pcs MA.252.A.LB.001 per PE Bag  
 Bag Dimensions - 300 x 200mm  
 Weight - 227g

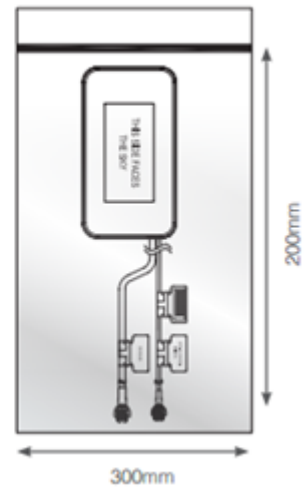

40 pcs MA.252.A.LB.001 per carton  
 Carton - 740x 370 x 300mm  
 Weight - 11.1Kg

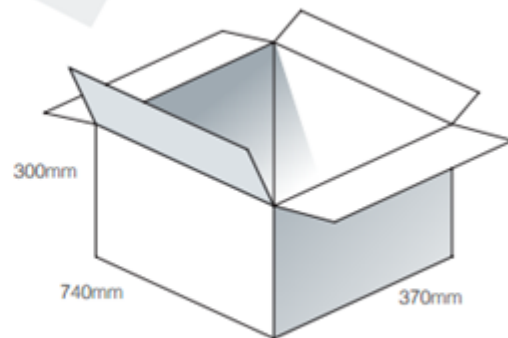

Pallet Dimensions 120 x 100x 140cm  
 12 Cartons per Pallet  
 6 Cartons per layer  
 2 Layers

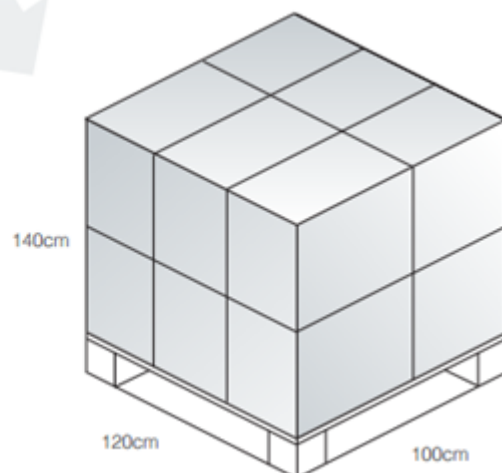

## 6. Application Note

Taoglas provides antennas with different cable lengths and various base mounting options to indicate its performance to act as a reference for a customer’s design.

### In Free Space

#### LTE

#### Return Loss

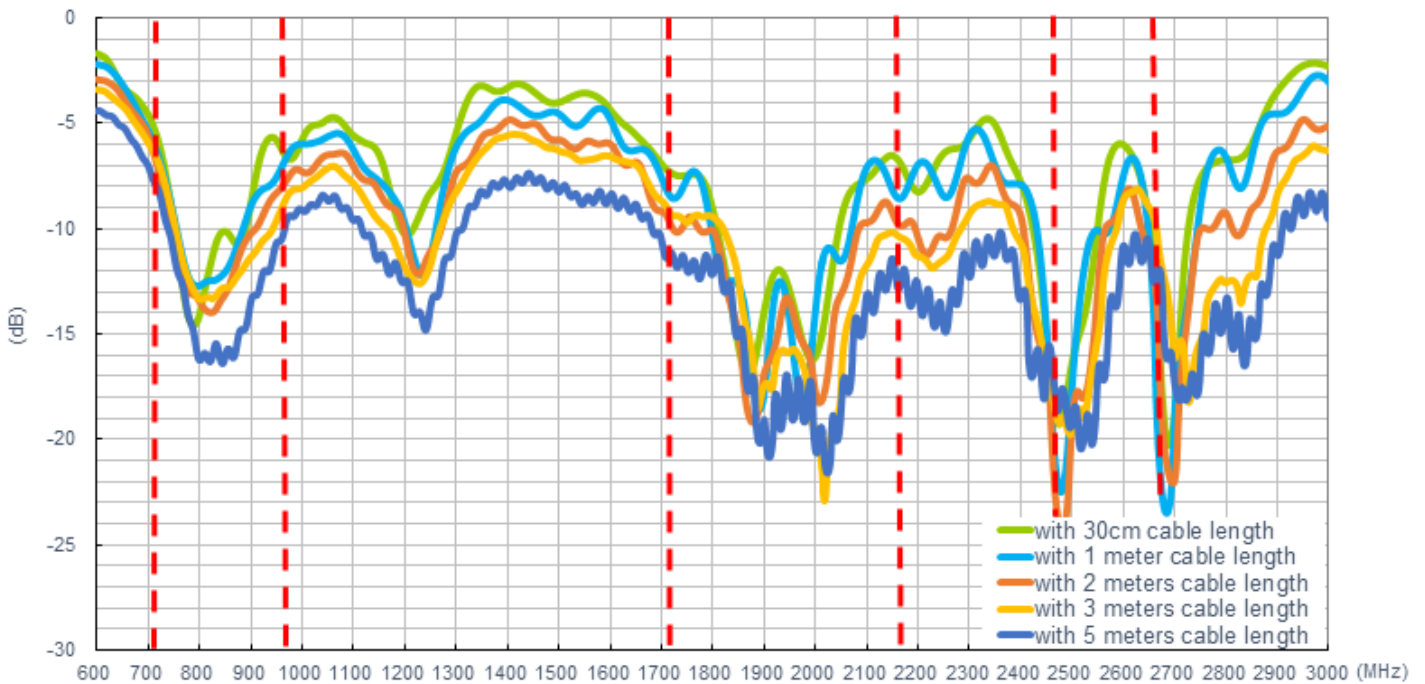



### Efficiency

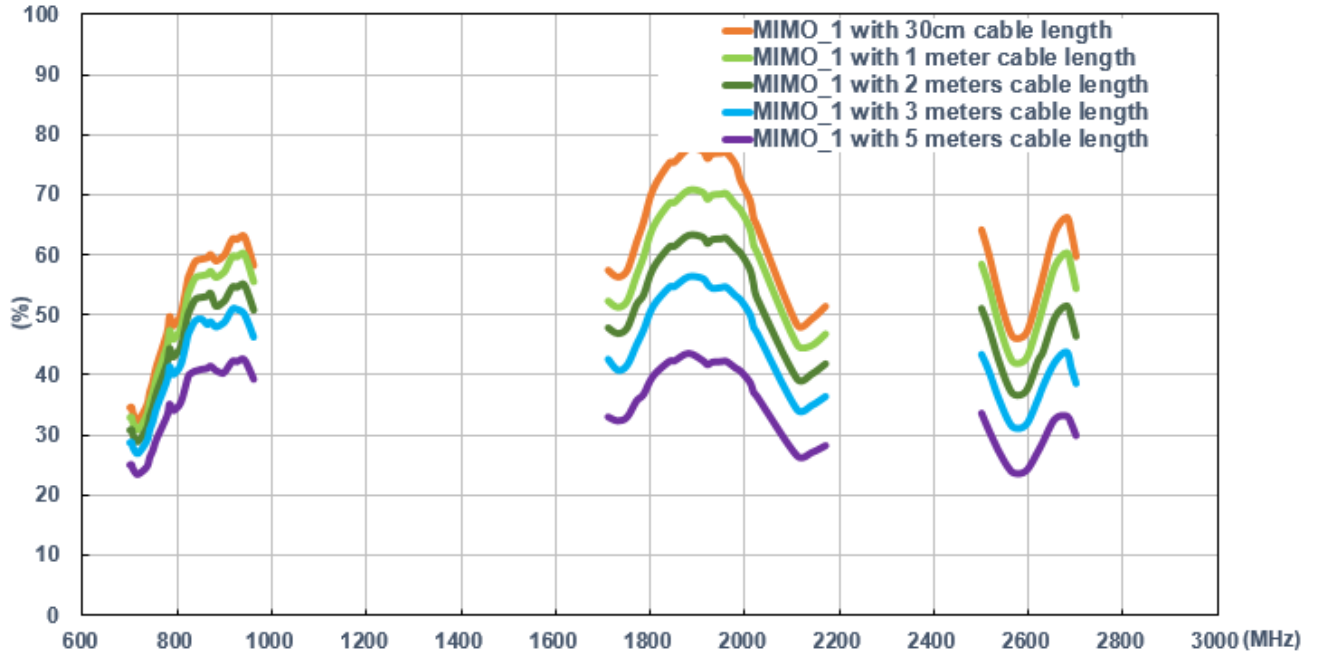

### Average Gain

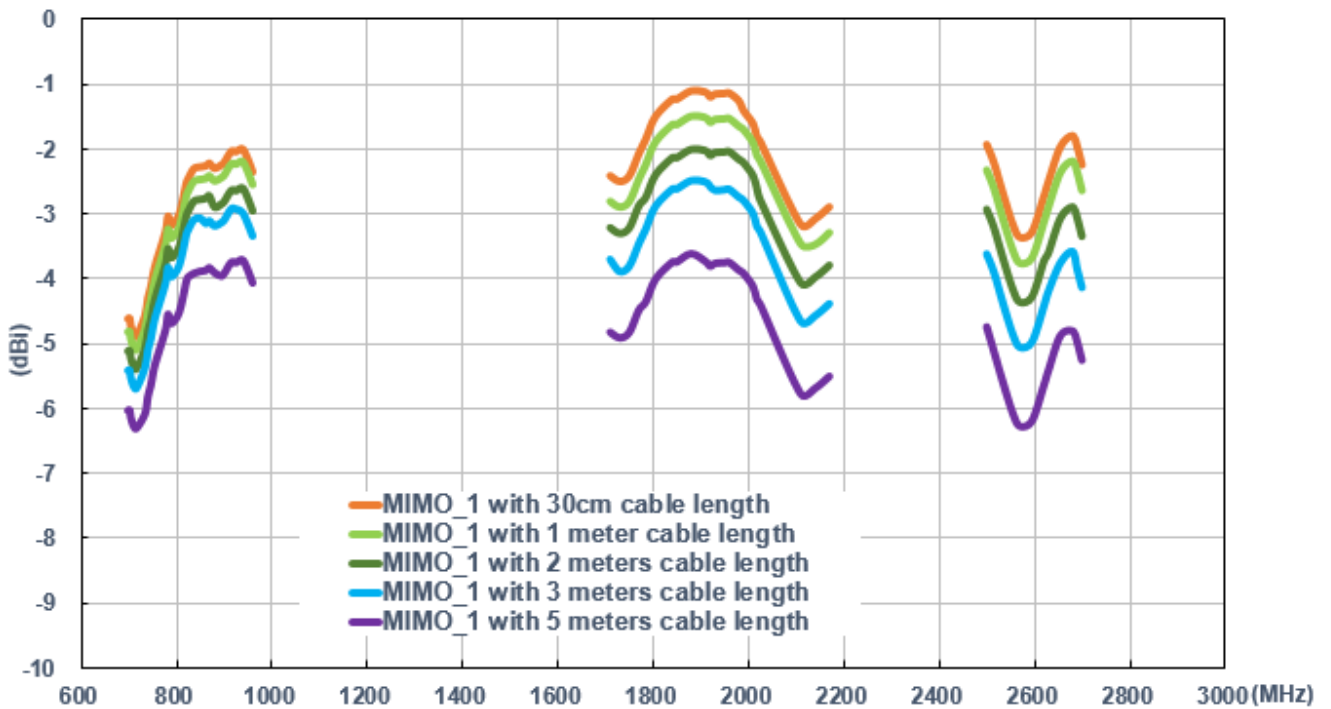

### Peak Gain

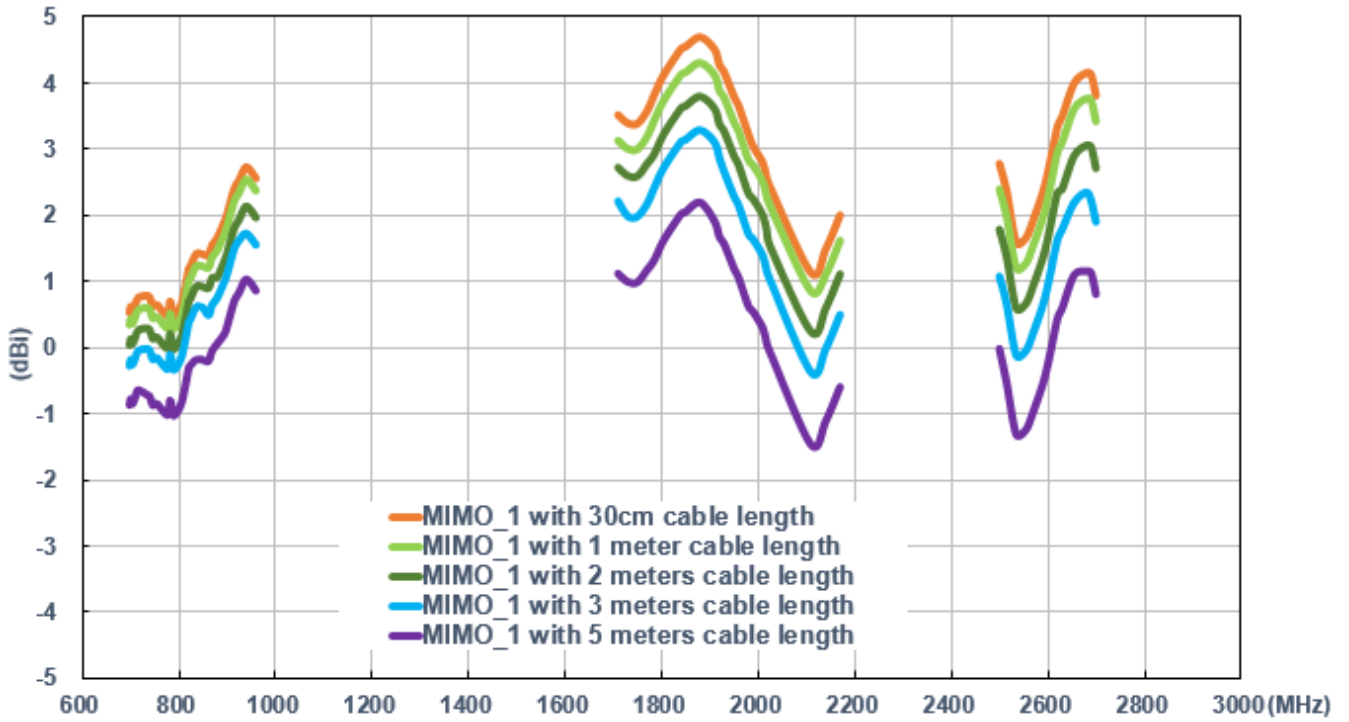

### On 2mm ABS

#### LTE

### Return Loss

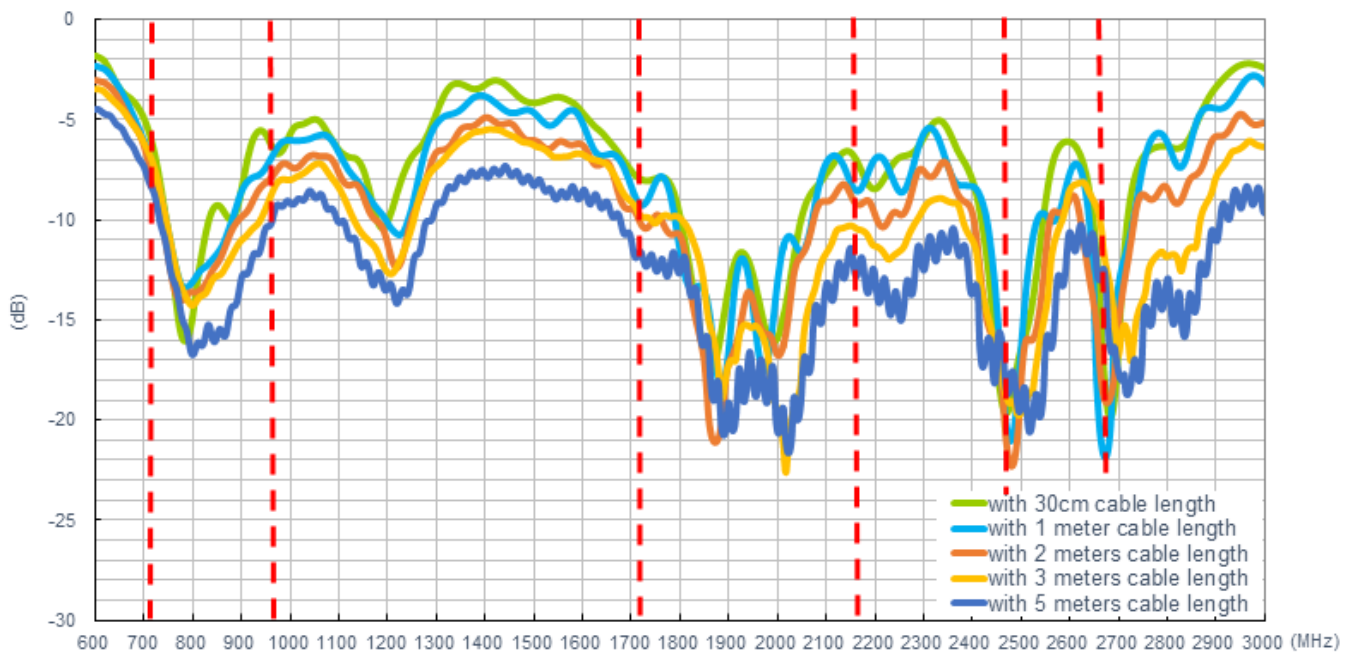

### Efficiency

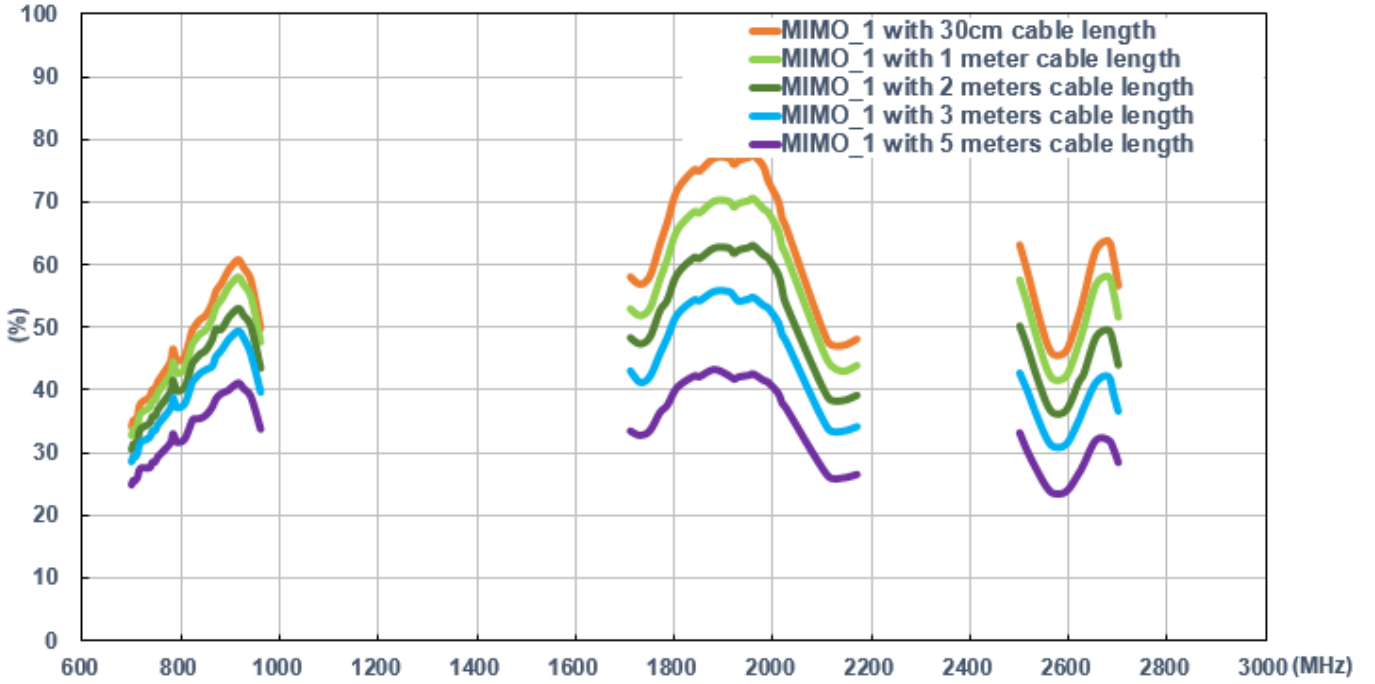

### Average Gain

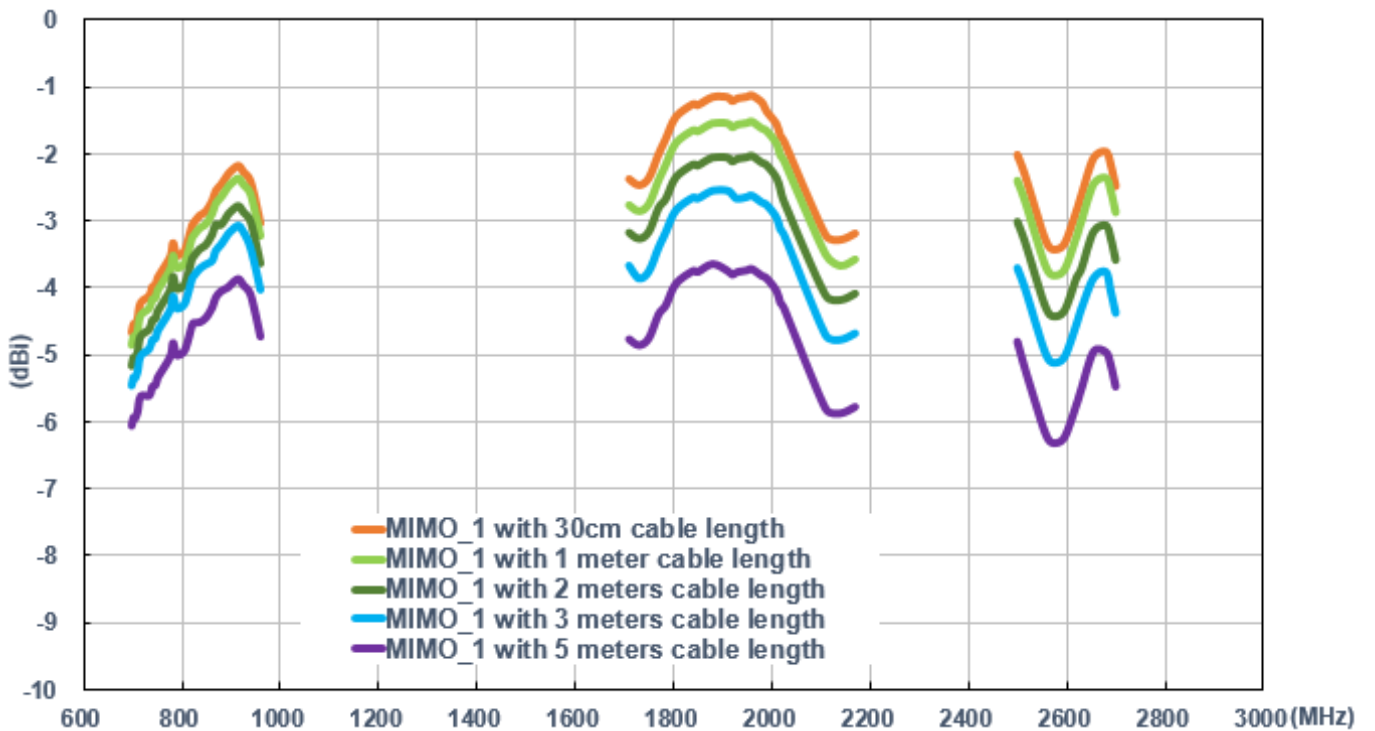

### Peak Gain

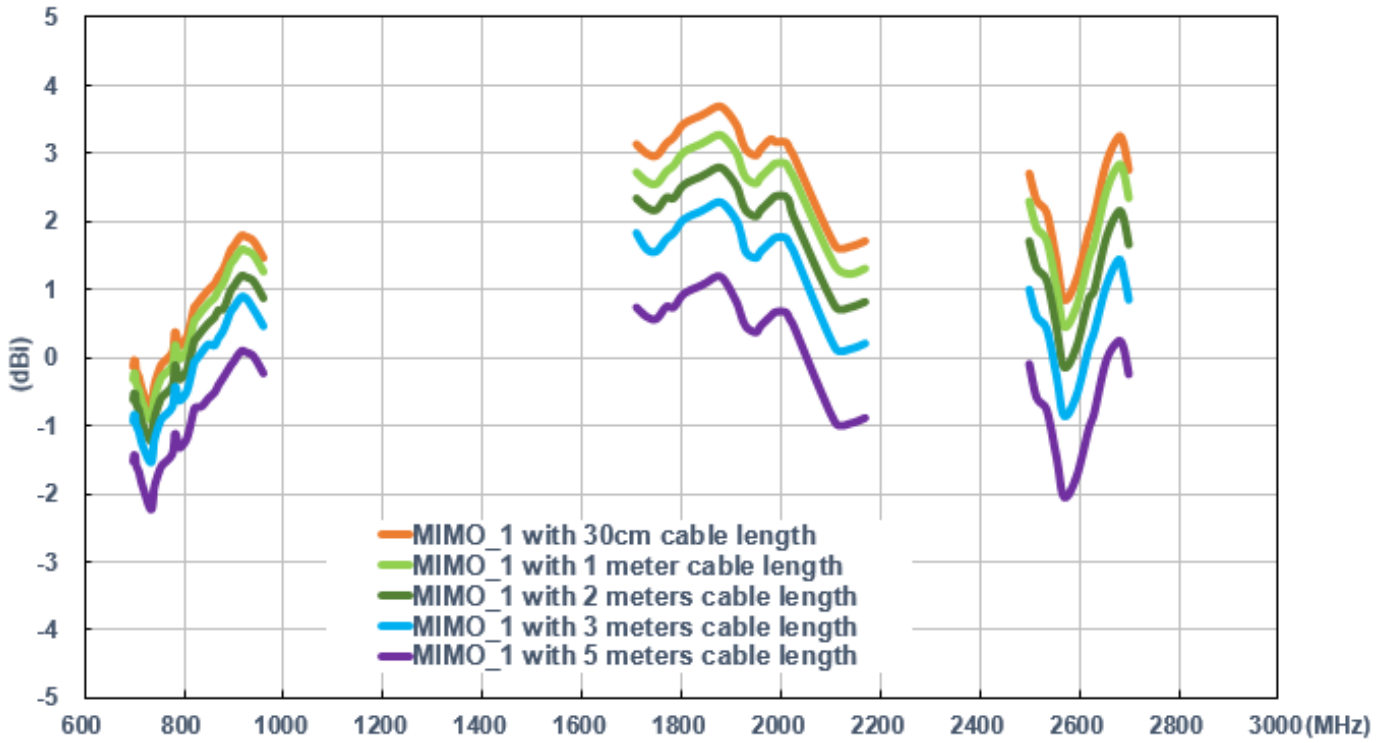

### On glass base

### LTE

### Return Loss

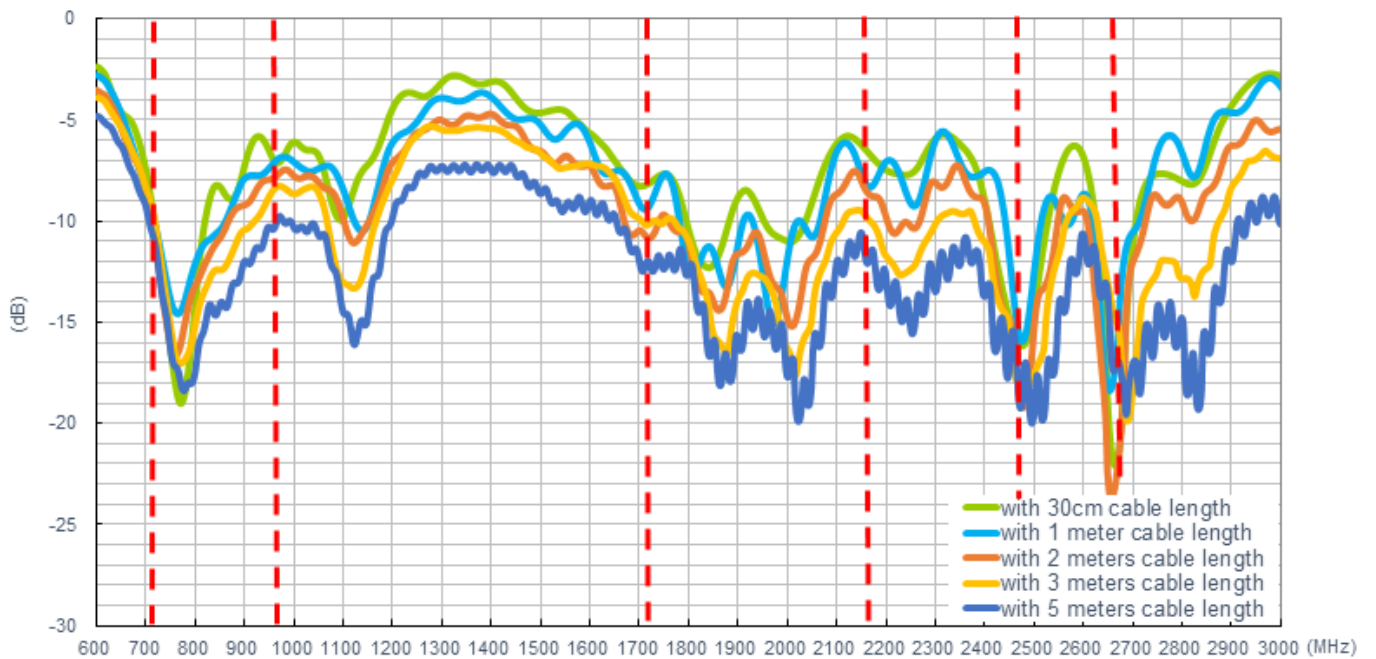

### Efficiency

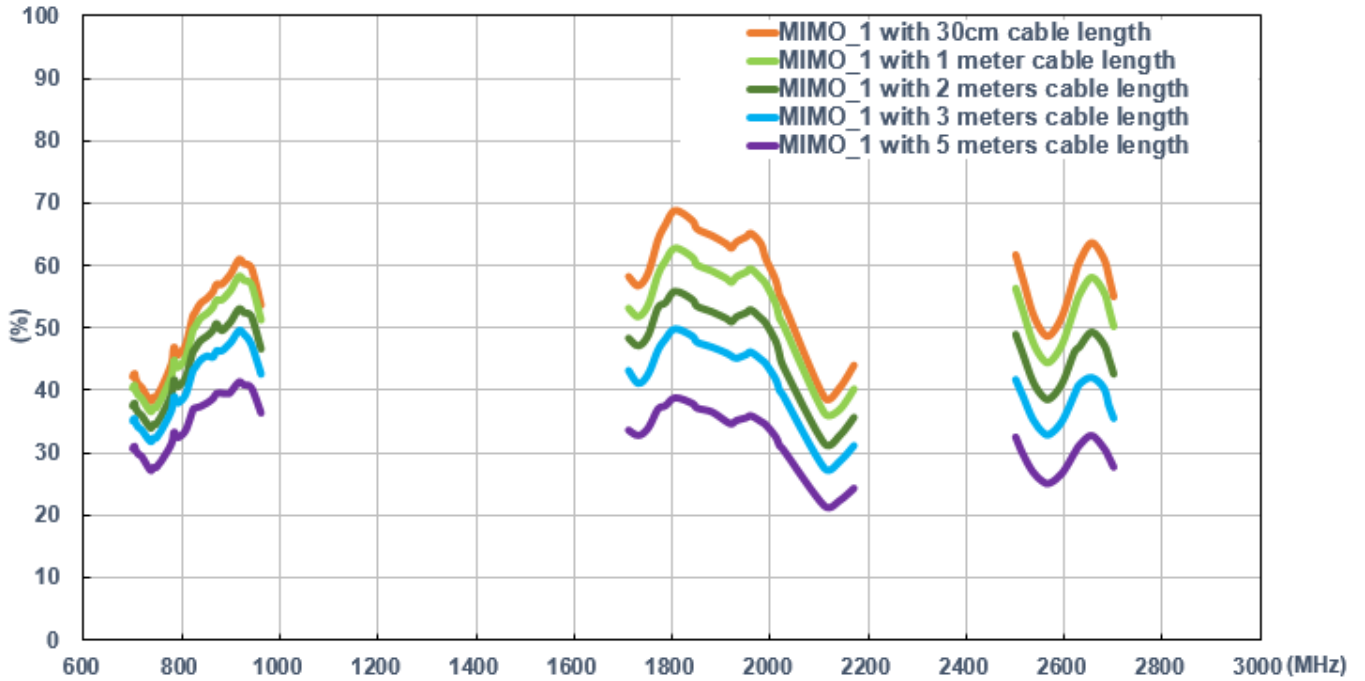

### Average Gain

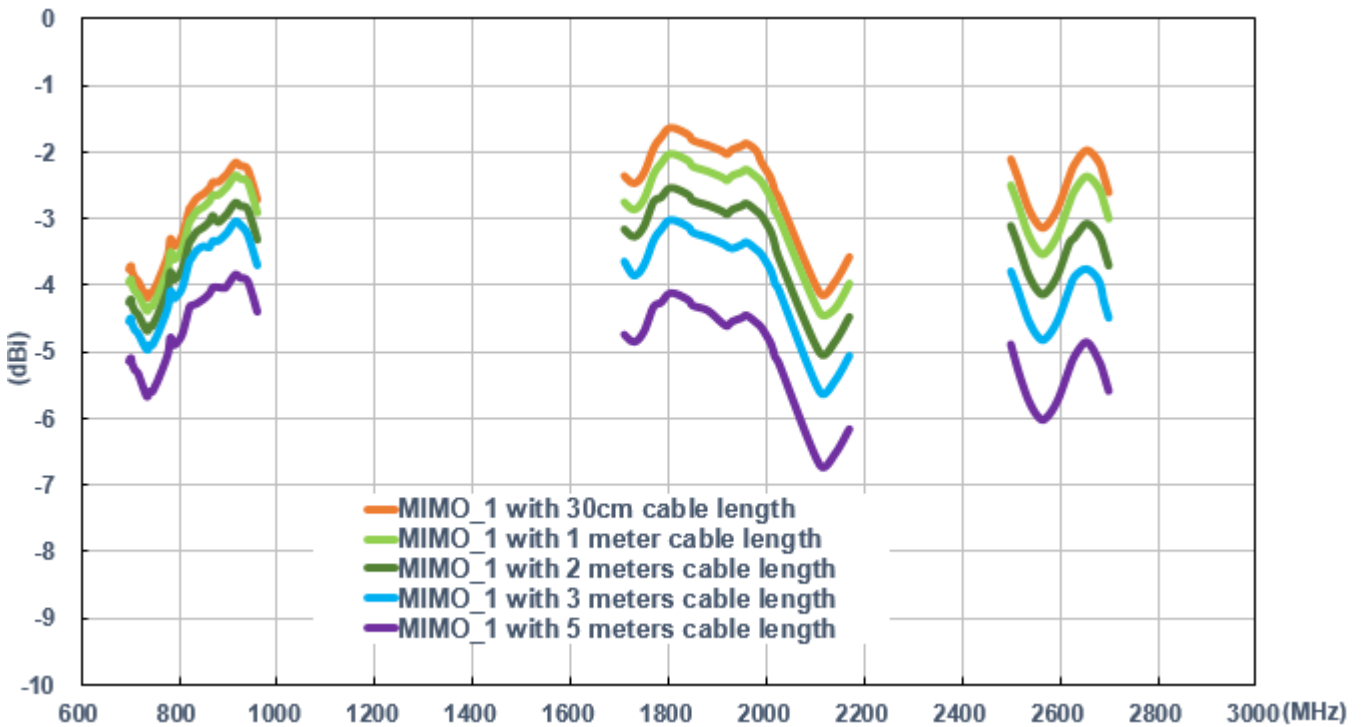

### Peak Gain

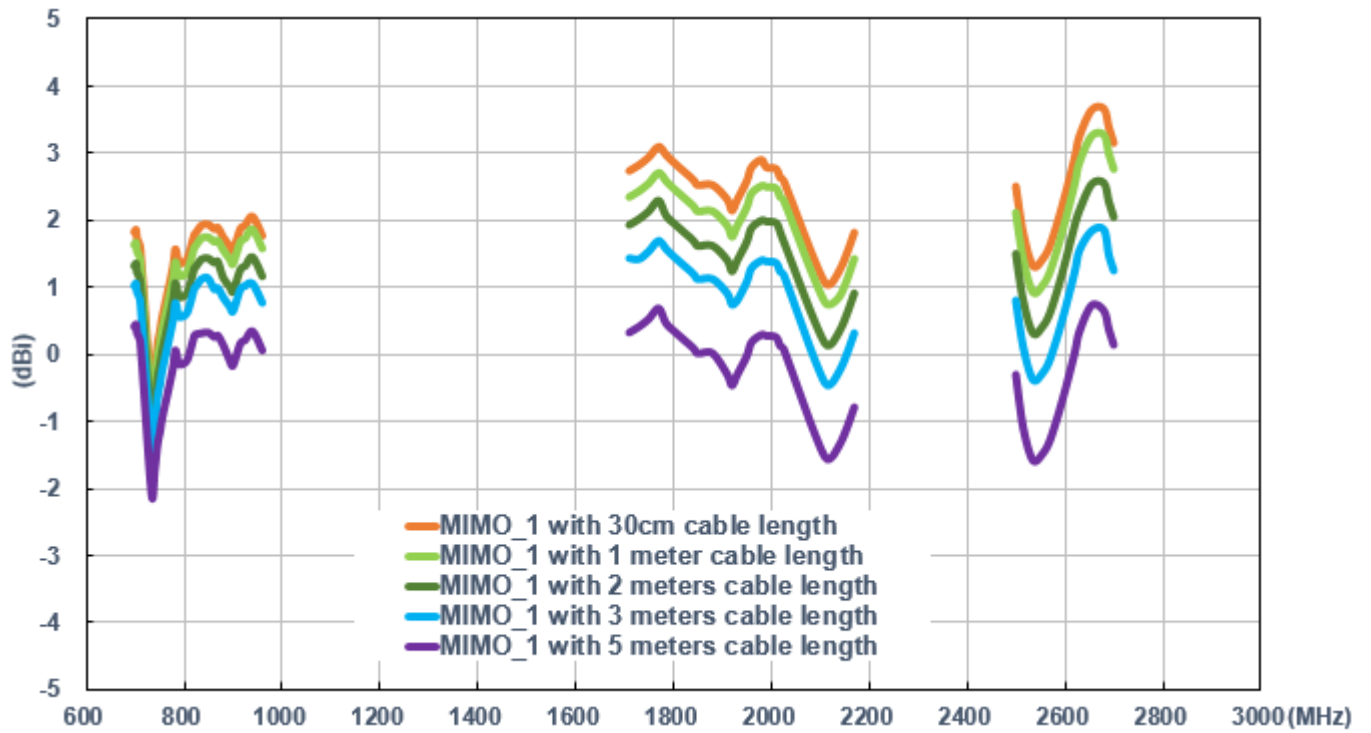



Taoglas makes no warranties based on the accuracy or completeness of the contents of this document and reserves the right to make changes to specifications and product descriptions at any time without notice.

Taoglas reserves the rights to this document and the information contained herein. Reproduction, use or disclosure to third parties without express permission is strictly prohibited.

Copyright © Taoglas Ltd.