

High Dynamic Range IF Amplifier 50 - 1000 MHz

Rev. V2

Features

- Single +5 V Supply Voltage
- 18 dB Gain
- +22 dBm P1dB
- +40 dBm OIP3
- 2.4 dB Noise Figure
- Lead-Free SOT-89 Package
- Halogen-Free “Green” Mold Compound
- RoHS* Compliant and 260°C Re-flow Compatible

Description

The MAAM-009116 is a high dynamic range amplifier in a lead-free SOT-89 surface mount plastic package. It can be operated from a single 5 volt supply.

The MAAM-009116 offers a combination of low noise figure, high gain, and high output IP3 making this an ideal IF amplifier for receiver and transmitter applications.

The MAAM-009116 is fabricated using M/A-COM Technology Solutions MESFET process to realize low noise and high dynamic range. The process features full passivation for performance and reliability.

Ordering Information ^{1,2}

Part Number	Package
MAAM-009116-000000	Bulk Packaging
MAAM-009116-TR3000	3000 piece reel
MAAM-009116-001SMB	500 MHz Configuration

1. Reference Application Note M513 for reel size information.
2. All sample boards include 5 loose parts.

Functional Block Diagram

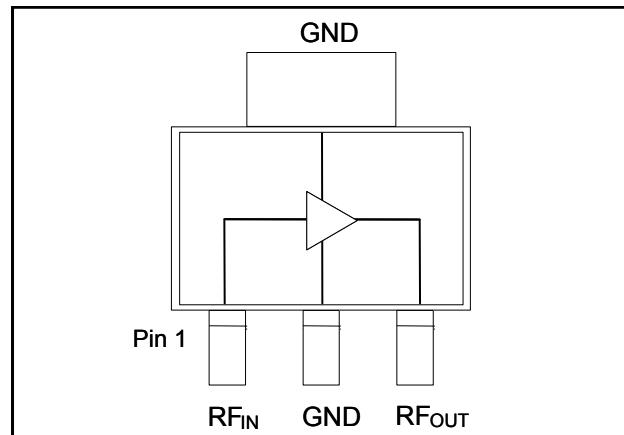

Pin Configuration

Pin No.	Function	Pin No.	Function
1	RF Input	3	RF Output/Bias
2	Ground	4	Ground

Maximum Operating Conditions ³

Parameter	Maximum Operating Conditions
Junction Temperature ⁴	150°C
RF Output Power	22 dBm
Operating Temperature	-40°C to +85°C

3. These operating conditions will ensure MTTF > 1 x 10⁶ hours.
4. Junction Temperature (T_J) = T_C + Θ_{JC} * ((V * I) - (P_{OUT} - P_{IN}))
Typical thermal resistance (Θ_{JC}) = 70° C/W.
a) For T_C = 25°C,
T_J = 88 °C @ 5 V, 180 mA, P_{OUT} = 5 dBm, P_{IN} = -13 dBm
b) For T_C = 85°C,
T_J = 143 °C @ 5 V, 165 mA, P_{OUT} = 4.7 dBm, P_{IN} = -13 dBm

Absolute Maximum Ratings ^{5,6}

Parameter	Absolute Maximum
RF Input Power	20 dBm
Voltage	6 volts
Storage Temperature	-55°C to +150°C
Junction Temperature	175°C

5. Exceeding any one or combination of these limits may cause permanent damage to this device.
6. M/A-COM Tech does not recommend sustained operation near these survivability limits.

* Restrictions on Hazardous Substances, European Union Directive 2002/95/EC.

High Dynamic Range IF Amplifier 50 - 1000 MHz

Rev. V2

Electrical Specifications for Single Ended Performance: $Z_0 = 50 \Omega$, $T_A = 25^\circ\text{C}$, $V_{DD} = +5\text{ V}$

Parameter	Test Conditions	Units	Min.	Typ.	Max.
Gain	500 MHz	dB	15	18	—
Noise Figure	500 MHz	dB	—	2.4	—
Input Return Loss	500 MHz	dB	—	13	—
Output Return Loss	500 MHz	dB	—	12	—
Output P1dB	500 MHz	dBm	—	22	—
Output IP ₃	500 MHz	dBm	37	40	—
Current	$V_{DD} = +5\text{ V}$	mA	—	180	200

PCB Layout

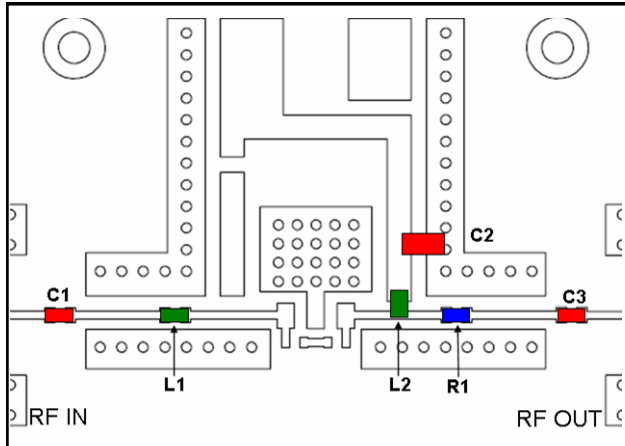

Parts List

Part	Value	Case Style	Manufacturer
C1,C3	1000 pF	0402	Murata
C2	0.018 μF	0805	Murata
L1	22 nH	0402	Coilcraft
L2	150 nH	0603	Coilcraft
R1	8.2 Ω	0402	Panasonic

Application Schematic

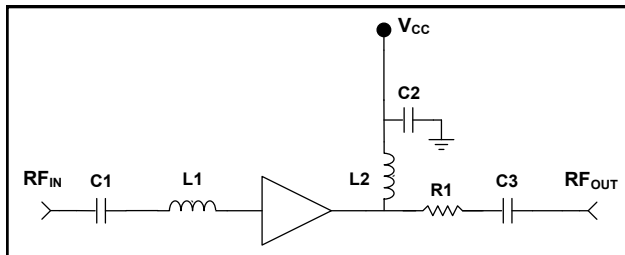

Typical Performance Curves

Gain

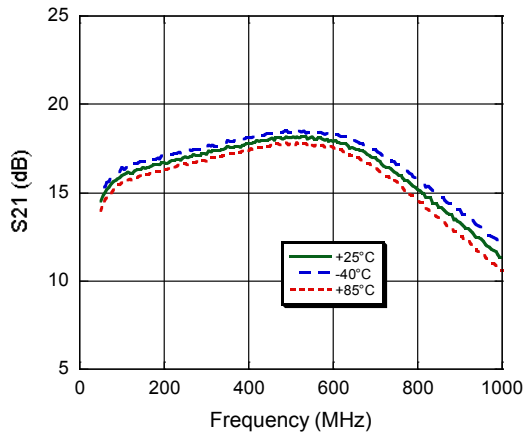

Input Return Loss

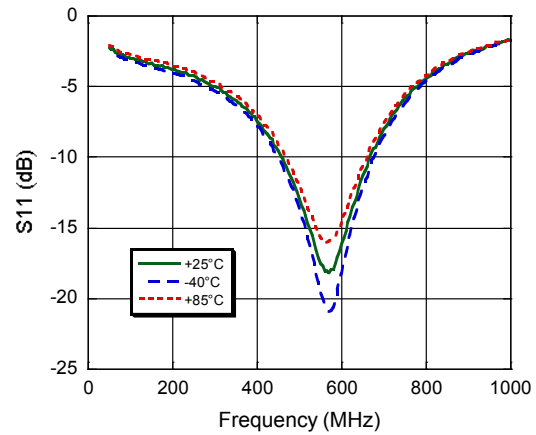

Output Return Loss

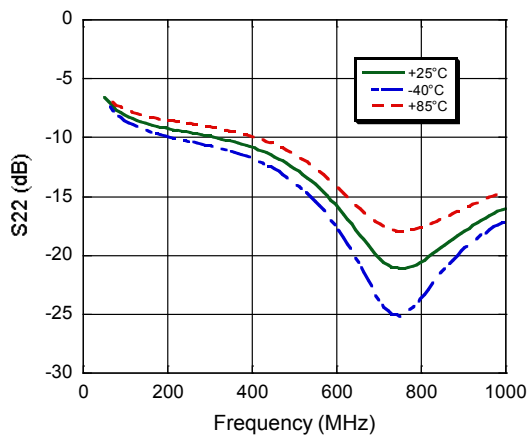

Noise Figure

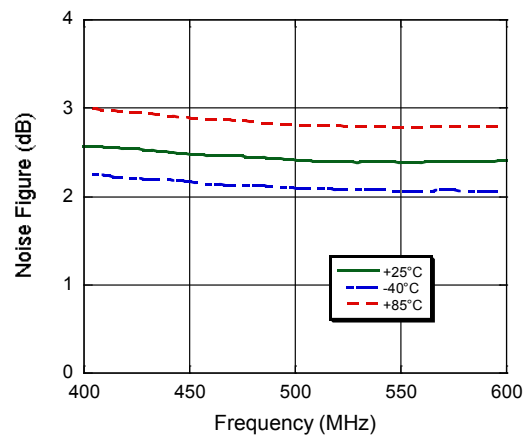

IP3

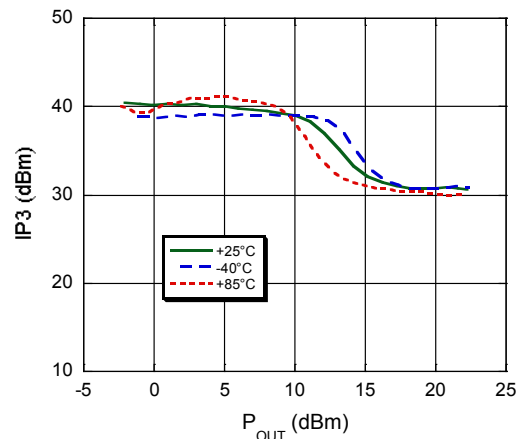

Gain

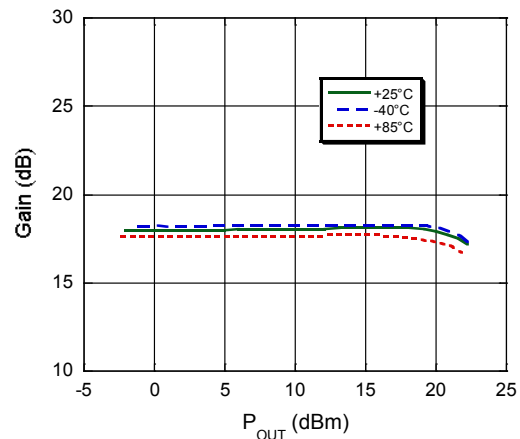

High Dynamic Range IF Amplifier 50 - 1000 MHz

Rev. V2

Typical Performance Curves

Current

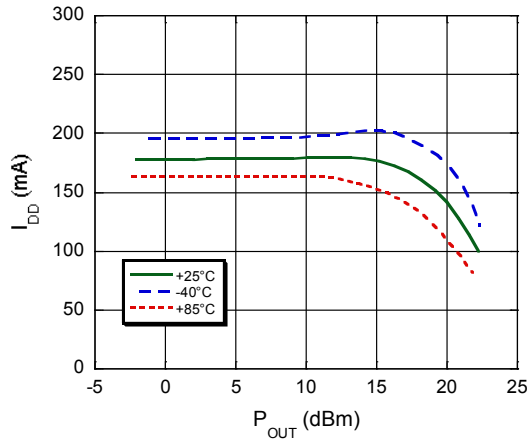

Handling Procedures

Please observe the following precautions to avoid damage:

Static Sensitivity

Gallium Arsenide Integrated Circuits are sensitive to electrostatic discharge (ESD) and can be damaged by static electricity. Proper ESD control techniques should be used when handling these devices.

Lead Free SOT-89 Plastic Package[†]

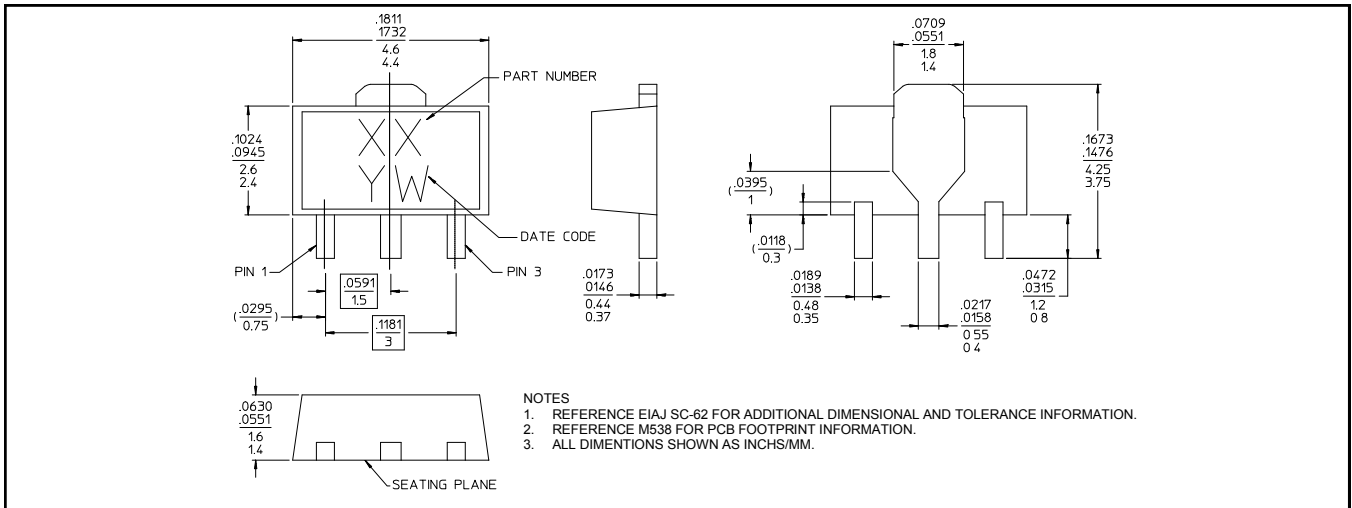

[†] Reference Application Note M538 for lead-free solder reflow recommendations.
Meets JEDEC moisture sensitivity level 1 requirements.
Plating is 100% matte tin over copper.

M/A-COM Technology Solutions Inc. All rights reserved.

Information in this document is provided in connection with M/A-COM Technology Solutions Inc ("MACOM") products. These materials are provided by MACOM as a service to its customers and may be used for informational purposes only. Except as provided in MACOM's Terms and Conditions of Sale for such products or in any separate agreement related to this document, MACOM assumes no liability whatsoever. MACOM assumes no responsibility for errors or omissions in these materials. MACOM may make changes to specifications and product descriptions at any time, without notice. MACOM makes no commitment to update the information and shall have no responsibility whatsoever for conflicts or incompatibilities arising from future changes to its specifications and product descriptions. No license, express or implied, by estoppel or otherwise, to any intellectual property rights is granted by this document.

THESE MATERIALS ARE PROVIDED "AS IS" WITHOUT WARRANTY OF ANY KIND, EITHER EXPRESS OR IMPLIED, RELATING TO SALE AND/OR USE OF MACOM PRODUCTS INCLUDING LIABILITY OR WARRANTIES RELATING TO FITNESS FOR A PARTICULAR PURPOSE, CONSEQUENTIAL OR INCIDENTAL DAMAGES, MERCHANTABILITY, OR INFRINGEMENT OF ANY PATENT, COPYRIGHT OR OTHER INTELLECTUAL PROPERTY RIGHT. MACOM FURTHER DOES NOT WARRANT THE ACCURACY OR COMPLETENESS OF THE INFORMATION, TEXT, GRAPHICS OR OTHER ITEMS CONTAINED WITHIN THESE MATERIALS. MACOM SHALL NOT BE LIABLE FOR ANY SPECIAL, INDIRECT, INCIDENTAL, OR CONSEQUENTIAL DAMAGES, INCLUDING WITHOUT LIMITATION, LOST REVENUES OR LOST PROFITS, WHICH MAY RESULT FROM THE USE OF THESE MATERIALS.

MACOM products are not intended for use in medical, lifesaving or life sustaining applications. MACOM customers using or selling MACOM products for use in such applications do so at their own risk and agree to fully indemnify MACOM for any damages resulting from such improper use or sale.