

### Description

The EClamp®2357NQ is a low pass filter array with integrated TVS diodes. It is designed to suppress unwanted EMI/RFI signals and provide electrostatic discharge (ESD) protection in portable electronic equipment. They have been optimized for protection of touch screen displays, secure digital (SD) card interfaces, and color LCD panels in cellular phones and other portable electronics.

The device consists of six pi filter circuits comprised of TVS diodes for ESD protection, and a resistor capacitor network for EMI/RFI filtering. A series resistor value of 100Ω and a component capacitance value of 10pF are used to achieve 20dB minimum attenuation from 1.0GHz to 3GHz. The device also includes 4 discrete TVS diodes for dedicated ESD protection. All of the TVS diodes provide effective suppression of ESD voltages in excess of ±15kV (air discharge) and ±8kV (contact discharge) per IEC 61000-4-2, level 4.

The EClamp2357NQ is qualified to AEC-Q100 Grade 1 for Automotive use.

### Features

- ◆ EMI/RFI filter with integrated ESD protection
- ◆ ESD protection to **IEC 61000-4-2 (ESD) Level4, ±15kV (air), ±8kV (contact)**
- ◆ Filter performance: **>30dB attenuation** at 1.8GHz
- ◆ TVS working voltage: 5V
- ◆ Resistor: 100Ω +/- 15%
- ◆ Component Capacitance: 10pF (VR = 0V)
- ◆ EMI & ESD protection for six lines
- ◆ Dedicated ESD protection for four lines
- ◆ Solid-state technology
- ◆ AEC-Q100 Grade 1 Qualified.

### Mechanical Characteristics

- ◆ 16 pin QFN
- ◆ RoHS/WEEE Compliant
- ◆ Nominal Dimensions: 3.0 x 3.0 x 1.0 mm
- ◆ Lead Pitch: 0.5mm
- ◆ Lead Finish: Matte Tin
- ◆ Marking: Marking Code
- ◆ Packaging: Tape and Reel per EIA 481

### Applications

- ◆ Touch Screen Display Interfaces
- ◆ Secure Digital (SD) Memory Card Interfaces
- ◆ Multimedia Card Interfaces (MCI)
- ◆ Color LCD Panel Protection
- ◆ Cell Phone Handsets and Accessories
- ◆ Automotive Applications.

### Package Dimensions

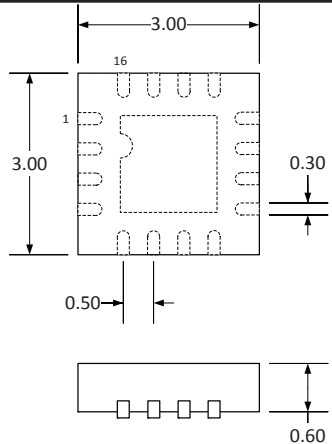

**16 Pin QFN (Top Side View)  
Nominal Dimensions (in mm)**

### Schematic & Pin Configuration

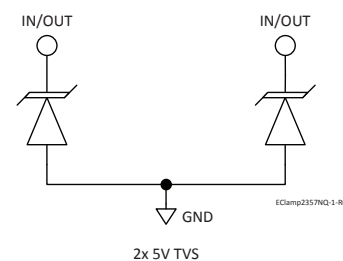
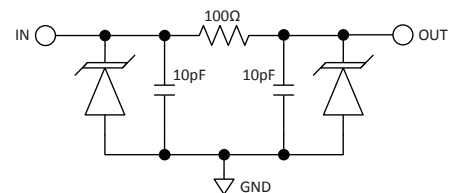

## PROTECTION PRODUCTS

### Absolute Maximum Ratings

Rating	Symbol	Value	Units
ESD per IEC61000-4-2 (Air) ESD per IEC61000-4-2 (Contact)	$V_{ESD}$	$\pm 20$ $\pm 12$	kV
Junction Temperature	$T_J$	125	$^{\circ}\text{C}$
Operating Temperature	$T_{OP}$	-40 to +125	$^{\circ}\text{C}$
Storage Temperature	$T_{STG}$	-55 to +150	$^{\circ}\text{C}$

### Electrical Characteristics (T=25 $^{\circ}\text{C}$ unless otherwise specified)

Parameter	Symbol	Conditions	Min.	Typ.	Max.	Units	
TVS Reverse Stand-Off Voltage	$V_{RWM}$				5	V	
TVS Reverse Breakdown Voltage	$V_{BR}$	$I_t = 1\text{mA}$ $T = -40 \text{ to } +125^{\circ}\text{C}$	6	8	10	V	
TVS Reverse Leakage Current	$I_R$	$V_{RWM} = 3.3\text{V}$ $T = -40 \text{ to } +125^{\circ}\text{C}$			0.5	$\mu\text{A}$	
Total Series Resistance	R	Each Line $T = -40 \text{ to } +125^{\circ}\text{C}$	85	100	115	$\Omega$	
Total Capacitance	$C_{IN}$	Input to Gnd Each Line $f = 1\text{MHz}$	$V_R = 0\text{V}$		20	22	pF
			$V_R = 2.5\text{V}$		12	15	

**Typical Insertion Loss S21 (Each Filter)**

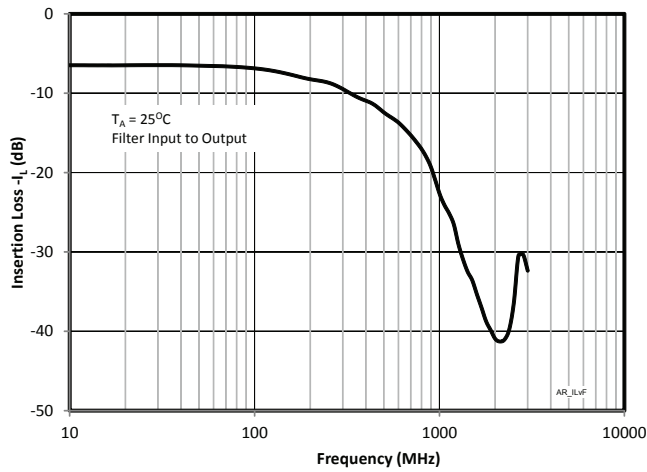

**Analog Crosstalk (Each Line)**

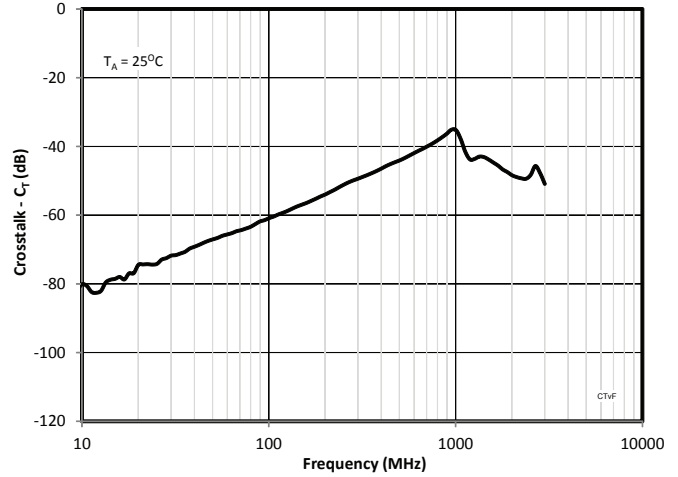

**ESD Clamping (+8kV Contact)**

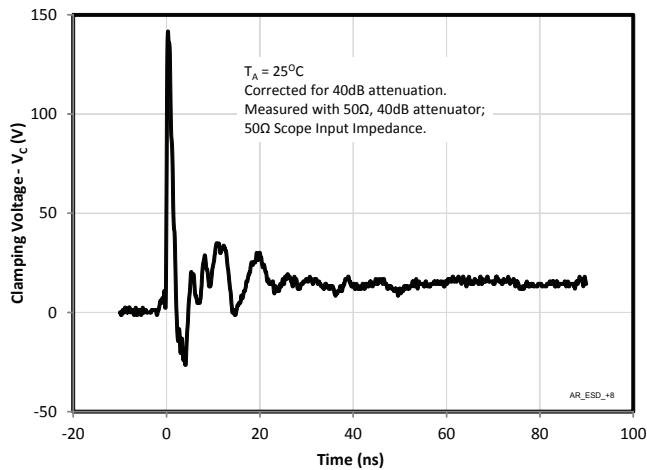

**ESD Clamping (-8kV Contact)**

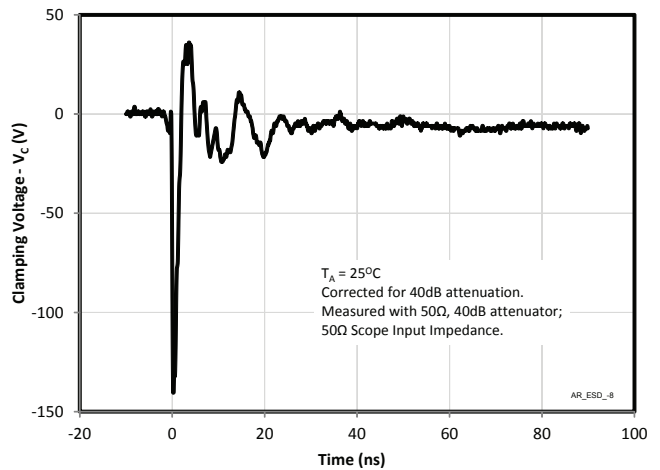

**Capacitance vs. Temperature**

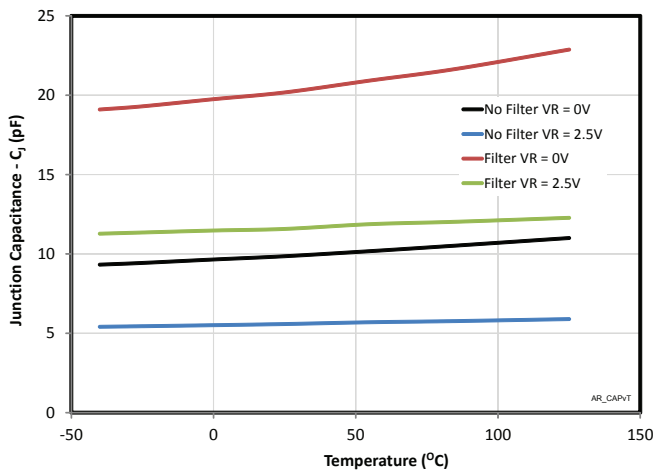

**Series Resistance vs. Temperature**

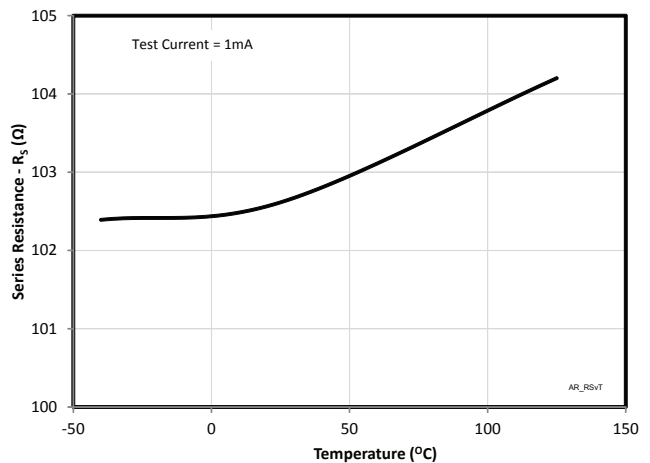

**Typical Characteristics (Continued)**

**Breakdown Voltage vs. Temperature**

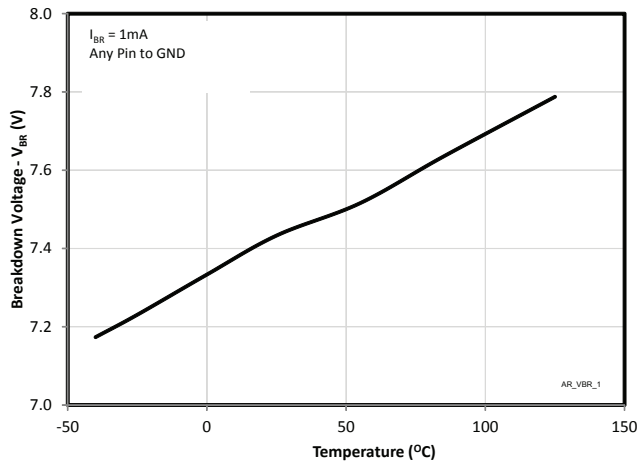

**Capacitance vs. Reverse Voltage**

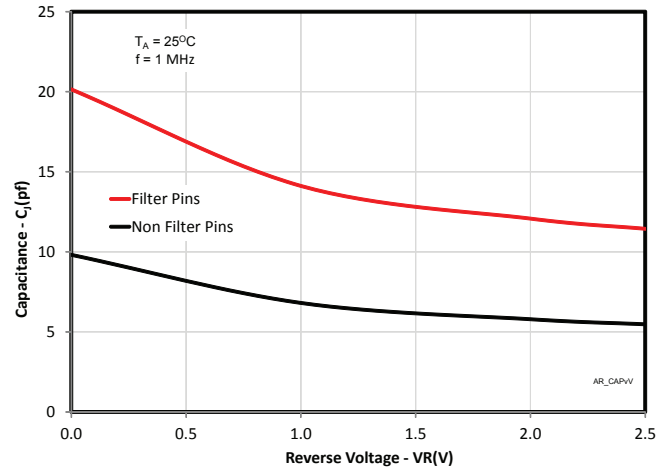

**TLP Charcteristics Positive**

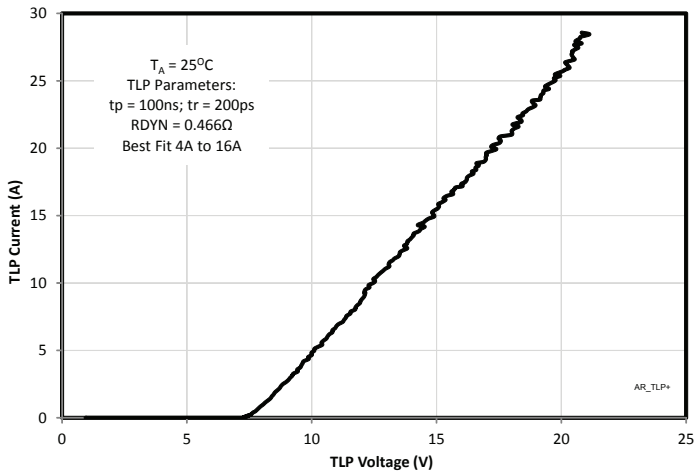

**TLP Charcteristics Positive**

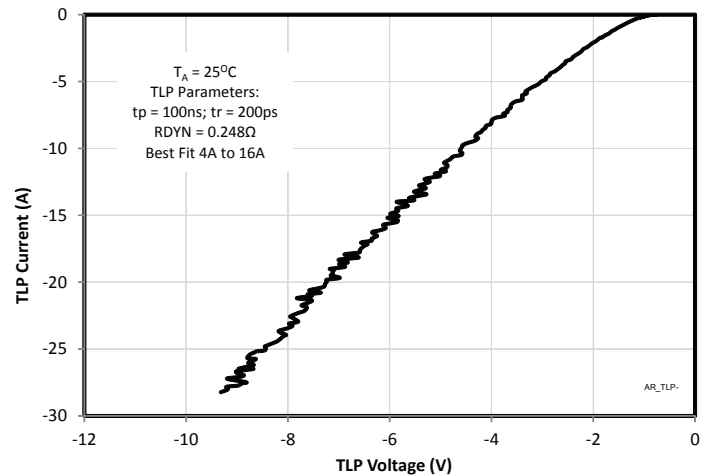

**Leakage Current vs. Temperature**

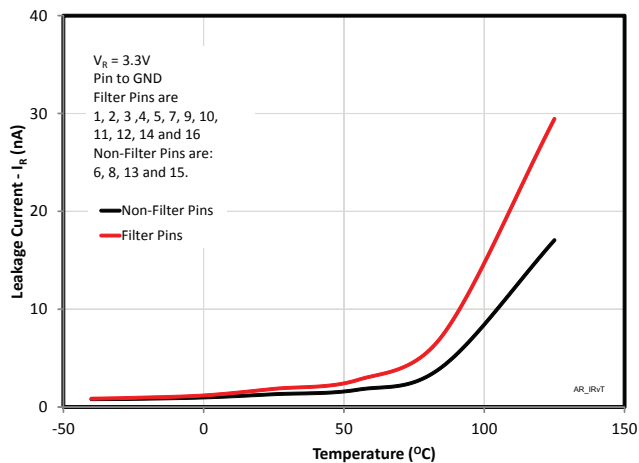

#### Device Connection

The EClamp2357NQ is comprised of six circuits each consisting of a low pass filter for EMI/RFI suppression and dual TVS diodes for ESD protection. It also includes 4 lines of TVS diodes for ESD protection of power lines or high speed I/O lines. The device is housed in a 16-pin Quad Flat No-Lead (QFN) package. Electrical connection is made via 16 pins located at the bottom of the device. A center tab serves as the ground connection. Pin connections are noted in the table to the right. The device is designed for easy PCB routing as shown in the application examples. All path lengths should be kept as short as possible to minimize the effects of parasitic inductance in the board traces.

#### Matte Tin Lead Finish

Matte tin has become the industry standard lead-free replacement for SnPb lead finishes. A matte tin finish is composed of 100% tin solder with large grains. Since the solder volume on the leads is small compared to the solder paste volume that is placed on the land pattern of the PCB, the reflow profile will be determined by the requirements of the solder paste. Therefore, these devices are compatible with both lead-free and SnPb assembly techniques. In addition, unlike other lead-free compositions, matte tin does not have any added alloys that can cause degradation of the solder joint.

#### Pin Identification and Configuration (Top Side View)

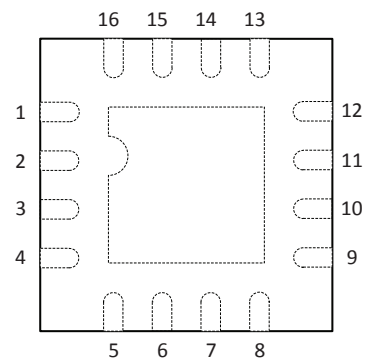

EClamp2357NQ-3-RO

Pin	Identification
3, 4, 5, 7, 9, 10	Input EMI/ESD Protected Lines
1, 2, 11, 12, 14, 16	Output EMI/ESD Protected Lines
6, 8, 13, 15	Input/Output ESD Protected Lines
Center Tab	Ground

#### Pin Configuration and Schematic

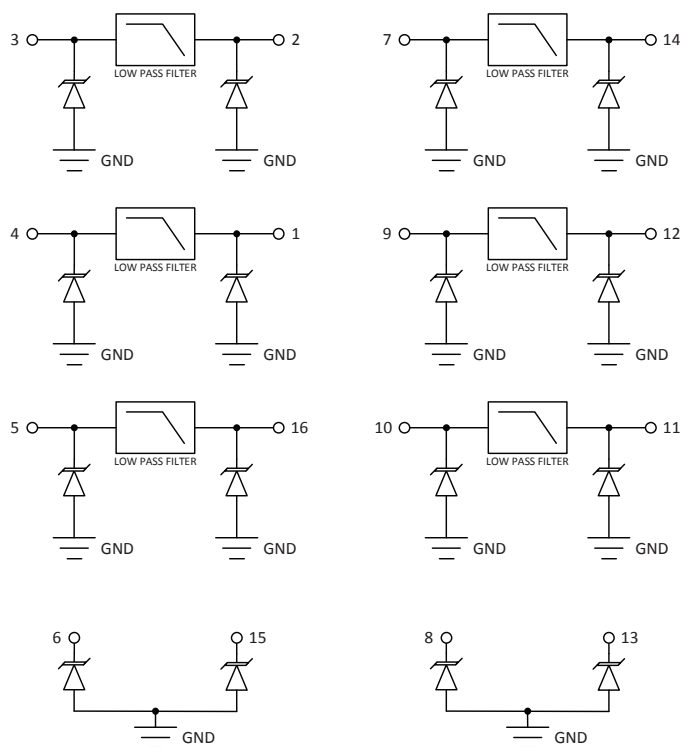

EClamp2357NQ-4-RO

EClamp2357NQ SD Memory

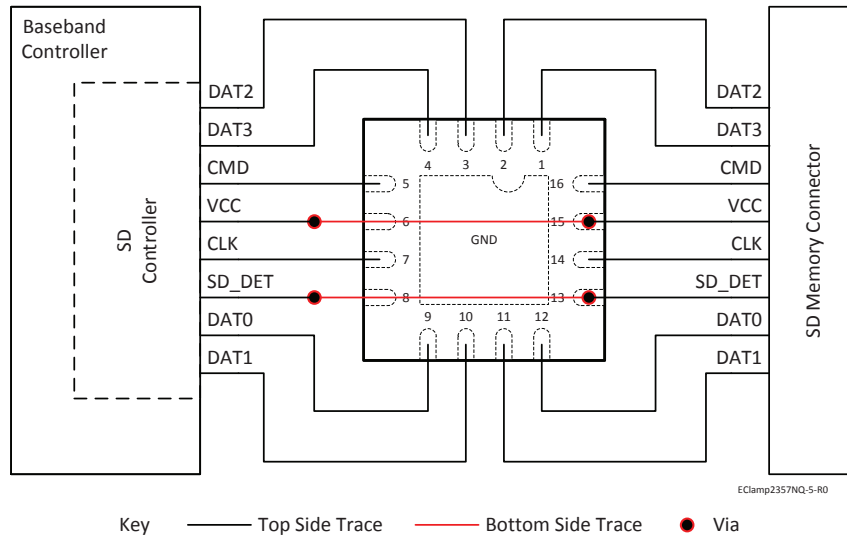

EClamp2357NQ LCD and Touch Pad

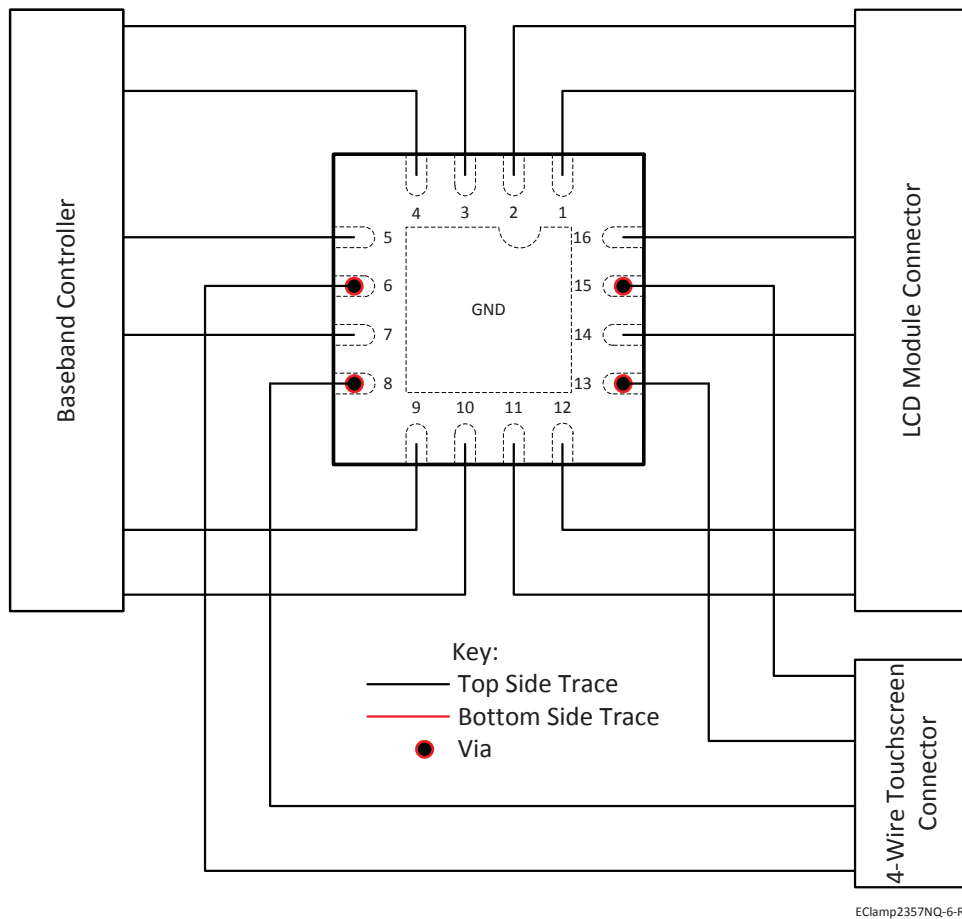

## PROTECTION PRODUCTS

### Outline Drawing - 16L QFN

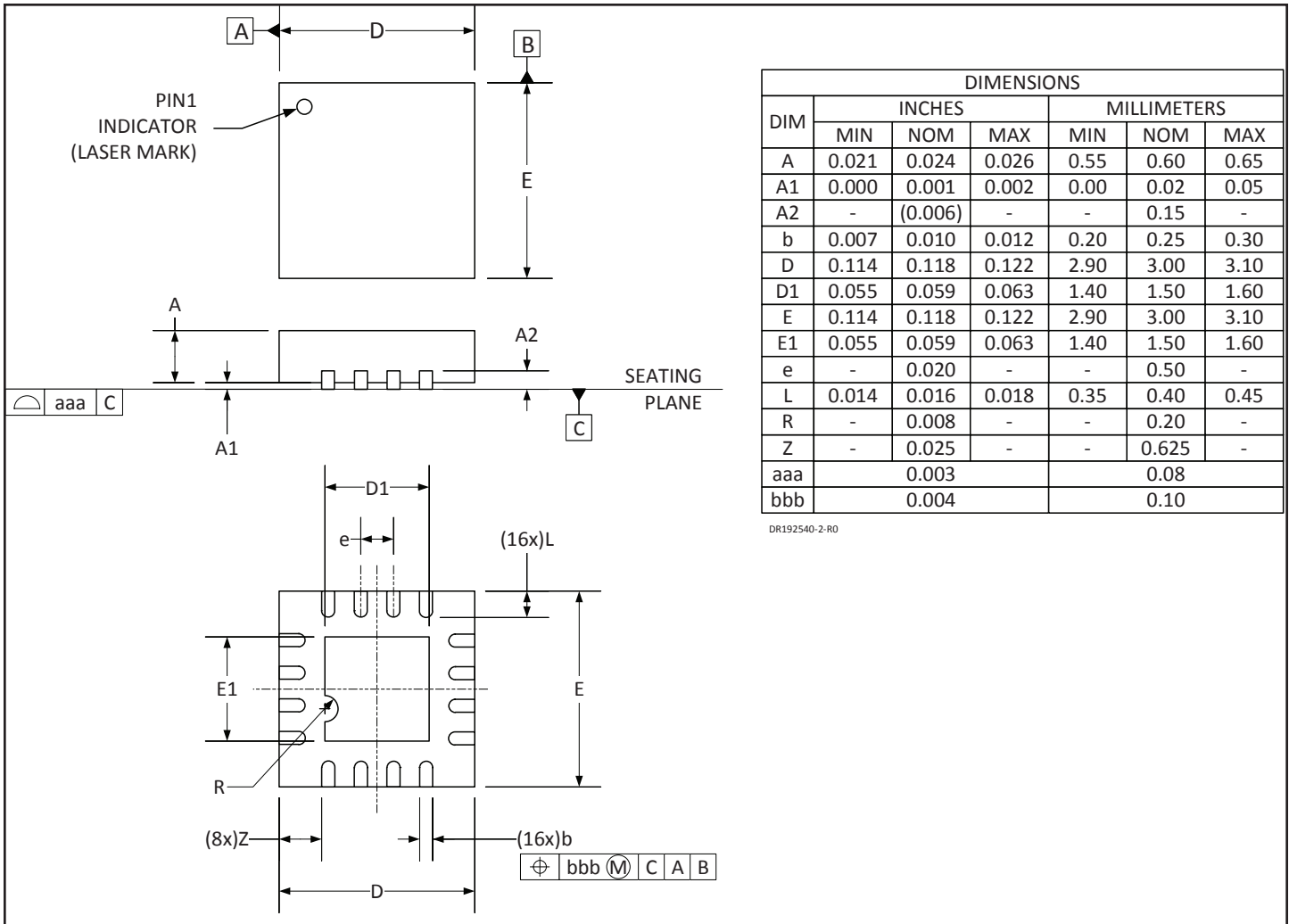

### Land Pattern - 16L QFN

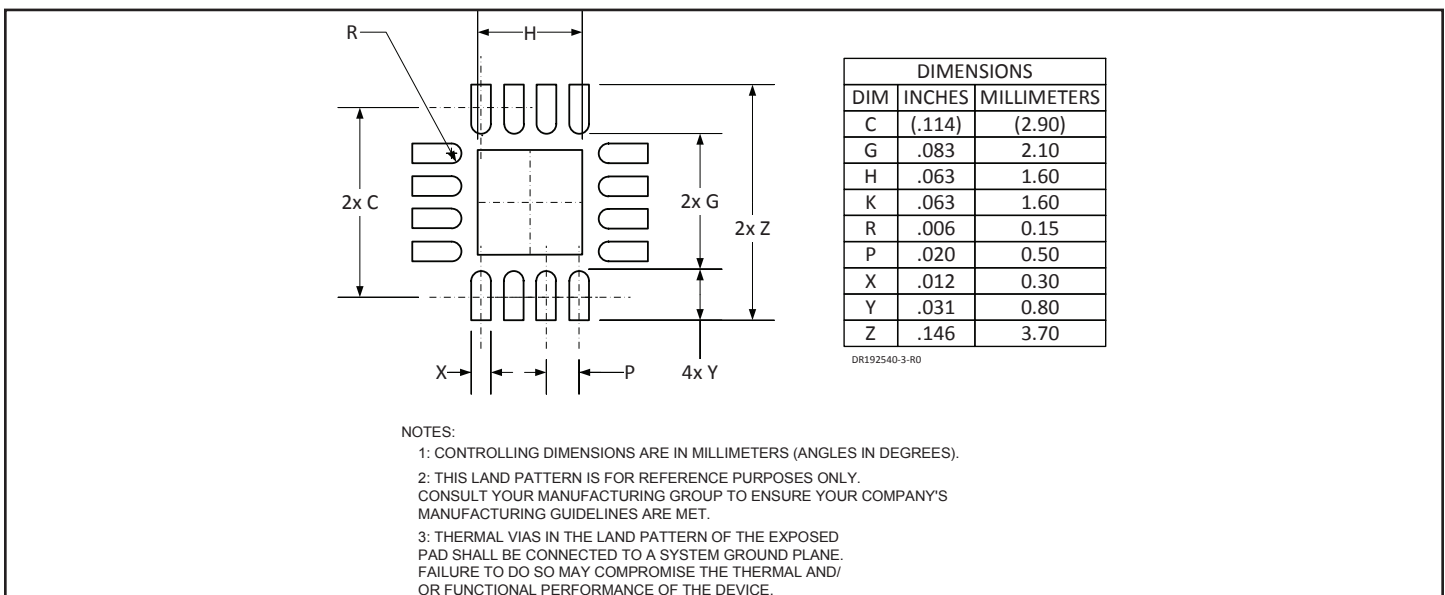

## PROTECTION PRODUCTS

### Marking

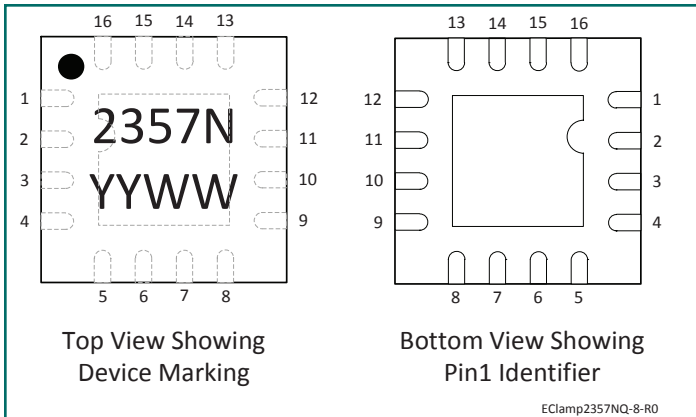

### Ordering Information

Part Number	Qty per Reel	Reel Size
EClamp2357NQTCT	3000	7 Inch

Note:  
EClamp and EMIClamp are registered marks of Semtech Corporation.

### Notes:

- 1) YYWW = Date Code
- 2) Pin 1 indicated by "Mouse Bite" on the ground pad

### Tape and Reel Specification

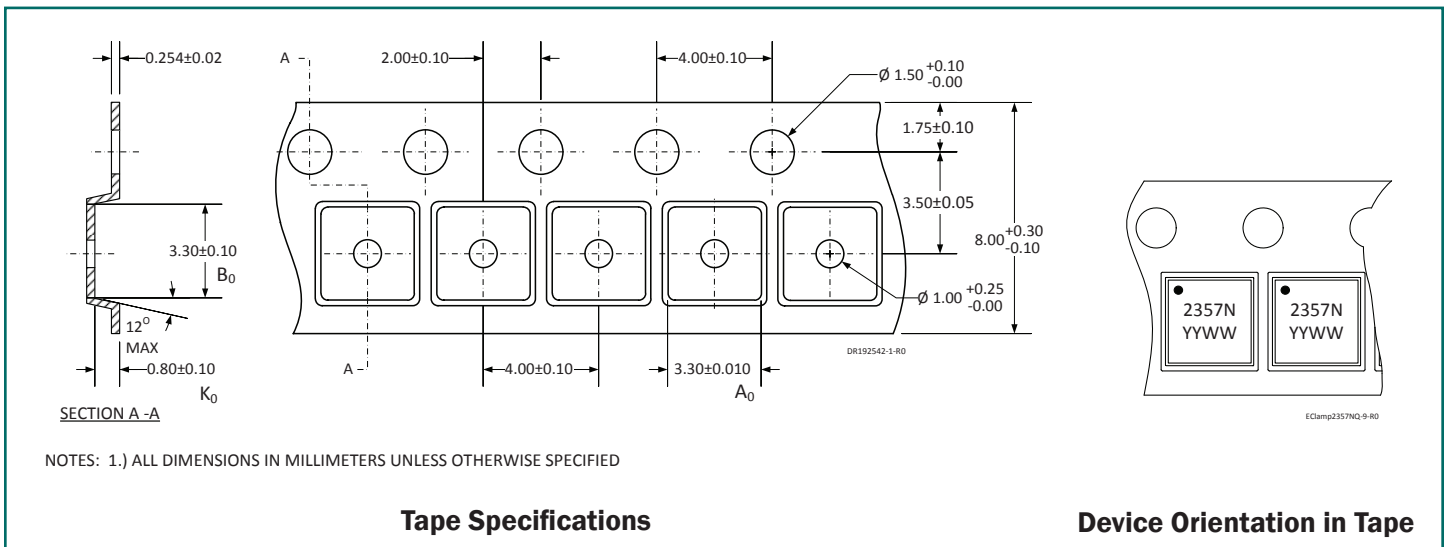

### Contact Information for Semtech International AG

Taiwan Branch	Tel: 886-2-2748-3380 Fax: 886-2-2748-3390	Japan (Tokyo) Office	Tel: 81-3-5719-7560 Fax: 81-3-5719-7561
Korea Branch	Tel: 82-2-527-4377 Fax: 82-2-527-4376	Semtech Limited (U.K.)	Tel: 44-1794-527-600 Fax: 44-1794-527-601
Shanghai Office	Tel: 86-21-6391-0830 Fax: 86-21-6391-0831	Semtech France SARL	Tel: 33-(0)169-28-22-00 Fax: 33-(0)169-28-12-98
Japan (Osaka) Office	Tel: 81-6-6347-6570 Fax: 81-6-6347-6571	Semtech Germany GmbH	Tel: 49-(0)8161-140-123 Fax: 49-(0)8161-140-124

Semtech International AG is a wholly-owned subsidiary of Semtech Corporation, which has its headquarters in the U.S.A.