

ALS50-24

Description:

The ALS50-24 is a single output power supply. It provides a DC output power in a cost-effective open frame package. Excellent performance specifications are provided, together with compliance to European EMC (EN55022, Class A), and Low Voltage directive (TUV EN60950).

Specifications (@25C)

Input Characteristics:

Input Voltage (5):	110/220Vac (90-260Vac, 120-370Vdc)
Input Frequency Range (1):	47-63Hz
Max Input Current:	1.0A @ 110Vac; 0.5A @ 220Vac
Max Inrush Current:	30A @ 220VAc
Hold-Up Time:	17ms typ @ 110Vac, 100% Load

Output Characteristics:

Output Voltage:	24.0Vdc
Output Current (1):	2.1A
Output Power (1):	50W
Ripple & Noise (20 MHz BW):	240mV
Line Regulation (4):	1.0%
Load Regulation (3):	2.0%
Temperature Drift:	0.02%/°C
Rise-up Time:	500ms max, 110Vac, 100% Load
Over Current Protection:	Shutdown, O.C.P Point>120%, recycle AC supply to recover
Over Voltage Protection:	>105% Zener across output
Short Circuit Protection:	Unit shutdown, recycle AC supply to recover
Adj. O/P Voltage Range (1,2):	±10%

Environmental Specifications:

EMI (Conducted RFI):	Built to comply with EN55022-B
EFT:	Built to comply with IEC61000-4-4
ESD:	Built to comply with IEC61000-4-2
Surge:	Built to comply with IEC61000-4-5
Operating Temperature:	Convection cooling 0 to 50°C:100%; 60°C:70%
Operating Humidity:	30% to 90% RH
Storage Temperature:	-25 to 85°C
Storage Humidity:	10% to 95% RH
Cooling:	Convection cooling
Vibration:	1min sweep 10-55Hz, 2G Amplitude, X,Y,Z axis 1hr each
Shock:	<20G

General Specifications:

Efficiency:	70% Typical
Dimensions (WxLxH):	76.20x127x35.56mm
Weight:	300g
Warranty:	2 years @ 40°C, 100% Load

Safety Standards:

Standard:	UL1950 (E204980) TUV EN60950 (50070245) Built to meet CSA 22.2
Dielectric Strength:	I/P-O/P:3kVac, I/P-FG:2.5kVac, <10mA, 1min
Insulation Resistance:	O/P-FG: 500VDC>100Mohms

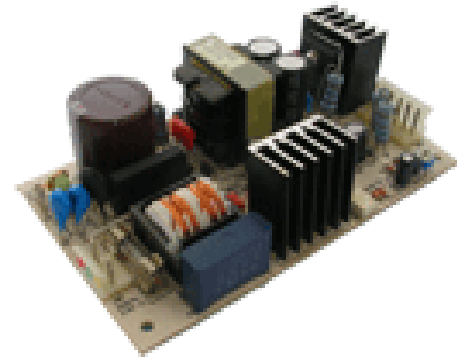

DERATING CURVE

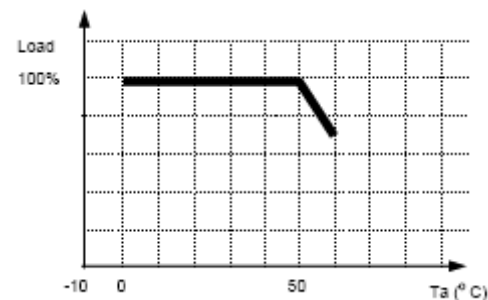

Technical Notes:

1. Throughout V_{in} range. V_{out} must be measured as near as possible to power supply.
2. Total output power by any combination of channel must not exceed $P_{ou(m)}$.
3. V_{out} deviation as I_{out} varies from $I_{o(min)}$ - $I_{o(max)}$.
4. V_{out} deviation as V_{in} varies from 90 – 260Vac.
5. Where UL and CSA is concerned, official rated input voltage range is 100-120Vac/200-240Vac.

Outline Dimensions (mm):

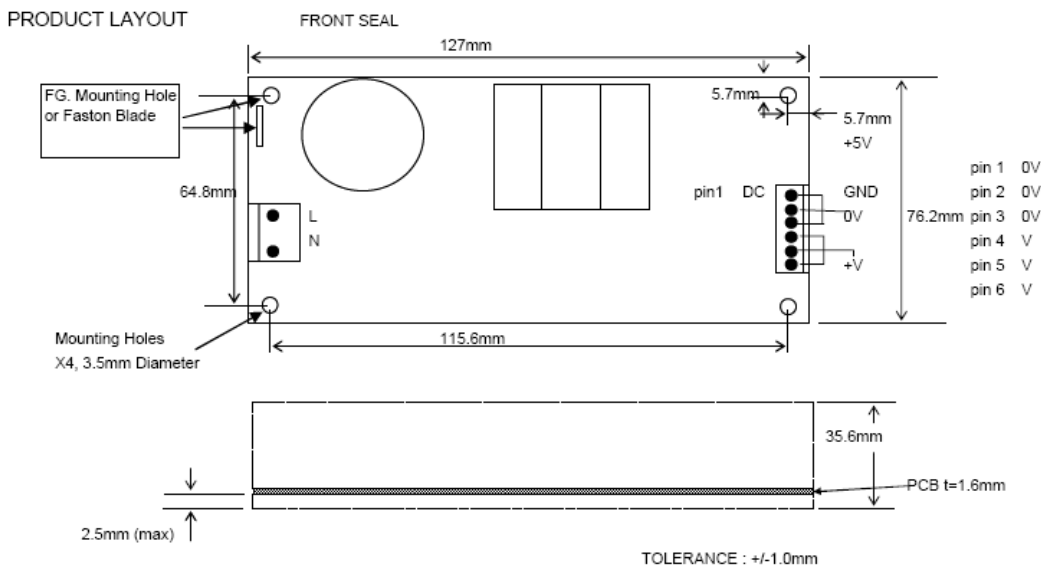

Mounting Method:

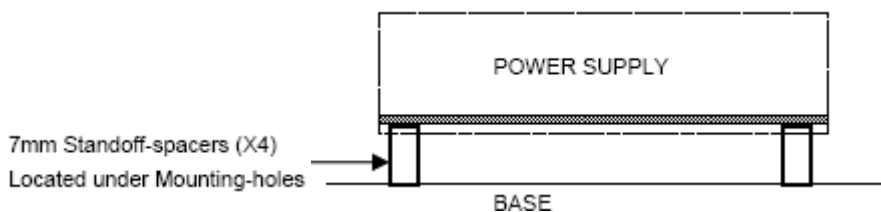

Connector Types:

AC Housing: Molex 09-50-3031
DC Housing: Molex 09-50-3061

Crimp Terminals: Molex 08-50-0105
Crimp Terminals: Molex 08-50-0105

RoHS Compliance: As of manufacturing date February 2005, all standard products meet the requirements of 2011/65/EU, known as the RoHS initiative.

* Upon printing, this document is considered "uncontrolled". Please contact Triad Magnetics' website for the most current version.