

GL527V/GL528V

Low Peak Forward Voltage Type $\phi 5\text{mm}$ Resin
Mold Type Infrared Emitting Diode

■ Features

1. Low peak forward voltage
(V_{FM} : TYP. 1.6V at $I_{FM}=0.5\text{A}$)
2. $\phi 5\text{mm}$ epoxy resin package

■ Applications

1. Infrared remote controllers for TVs, VCRs, audio equipment and air conditioners

■ Model Line-ups

	GL527V	GL528V
Radiation intensity (TYPmW/sr)	12	23
Half intensity angle (TYP deg)	± 21	± 13

■ Absolute Maximum Ratings (Ta = 25°C)

Parameter	Symbol	Rating	Unit
Forward current	I_F	100	mA
*1 Peak forward current	I_{FM}	1	A
Reverse voltage	V_R	6	v
power dissipation	P	150	mW
Operating temperature	T_{opr}	-25 to +85	°C
Storage temperature	T_{stg}	-40 to +100	°C
*2 Soldering temperature	T_{sol}	260	°C

*1 Pulse width $\leq 100 \mu\text{s}$, Duty ratio= 0.01

*2 For 3 seconds at the position of 2.6mm from the bottom face of resin package.

■ Electro-optical Characteristics (Ta = 25°C)

Parameter	Symbol	Conditions	M.T.N.	TYP.	MAX.	Unit
Forward voltage	V_F	$I_F = 50\text{mA}$	—	1.2	1.37	V
Peak forward voltage	V_{FM}	$I_{FM} = 0.5\text{A}$	—	1.6	2.5	V
Reverse current	I_R	$V_R = 3\text{V}$	—	—	10	μA
Radiation intensity	GL527V	$I_F = 50\text{mA}$	5	12	—	mW/sr
	GL528V		12	23	—	
Peak emission wavelength	λ_p	$I_F = 5\text{mA}$	—	940	—	nm
Half intensity wavelength	AL	$I_F = 5\text{mA}$	—	45	—	nm
Terminal capacitance	C_t	$V_R = 0, f = 1\text{MHz}$	—	50	—	pF
Response frequency	fc		—	300	—	kHz
Half intensity angle	GL527V	$I_F = 20\text{mA}$	—	± 21	—	°
	GL528V		—	± 13	—	

*3 I_E : Value obtained by converting the value in power of radiant fluxes emitted at the solid angle of 0.01 sr (steradian) in the direction of mechanical axis of the lens portion into 1 sr of all those emitted from the light emitting diode.

■ Outline Dimensions (Unit : mm)

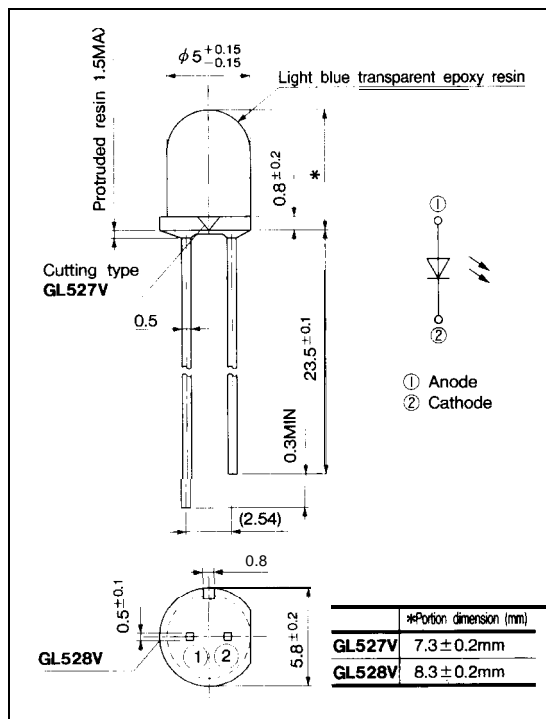

3

Infrared Emitting Diodes

Fig. 1 Forward Current vs. Ambient Temperature

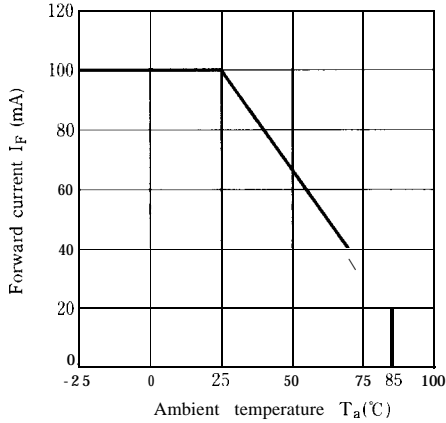

Fig. 2 Peak Forward Current vs. Duty Ratio

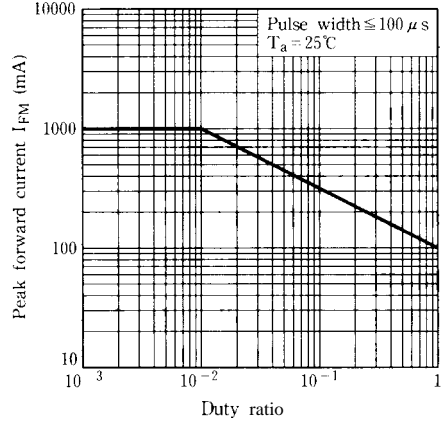

Fig. 3 Spectral Distribution

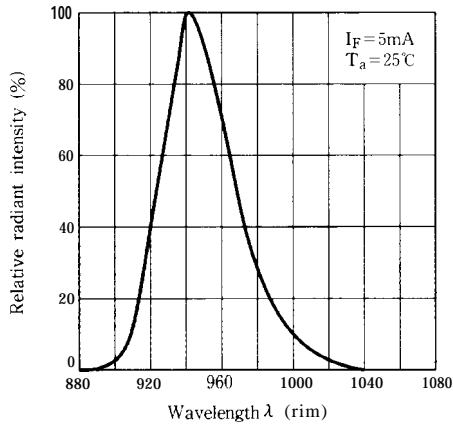

Fig. 4 Peak Emission Wavelength vs. Ambient Temperature

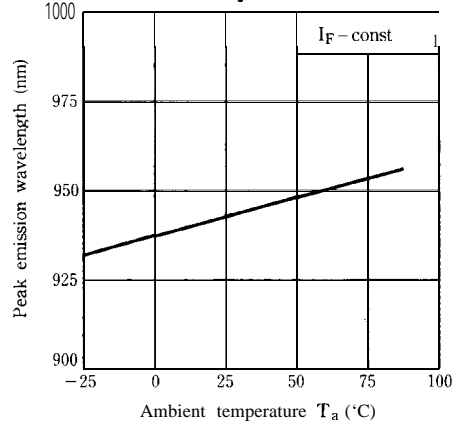

Fig. 5 Forward Current vs. Forward Voltage

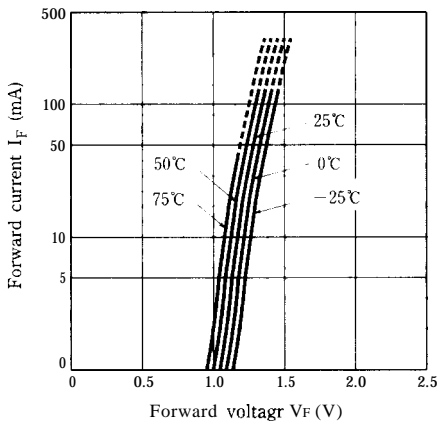

Fig. 6 Relative Forward Voltage vs. Ambient Temperature

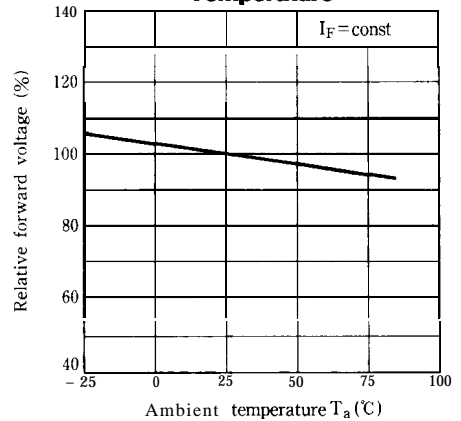

Fig. 7 Relative Output vs. Ambient Temperature
(Detector : PD410PI)

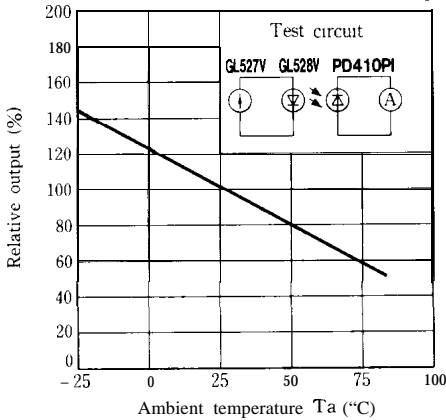

Fig. 8 Radiation intensity vs. Peak Forward Current

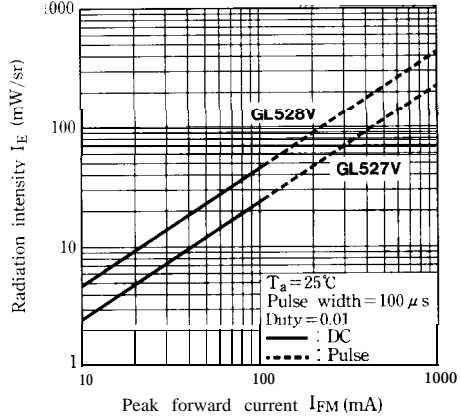

Fig. 9 Relative Collector Current vs. Distance
(Detector : PD410PI)

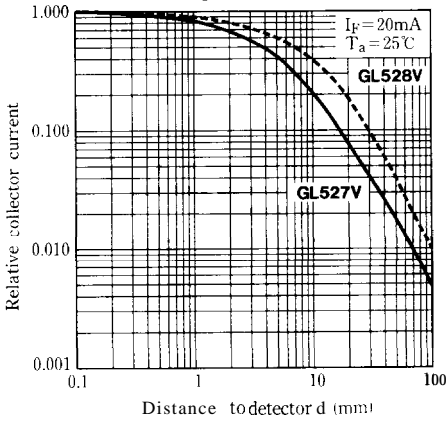

Fig.10 Relative Collector Current vs. Distance
(Detector : PD49PI)

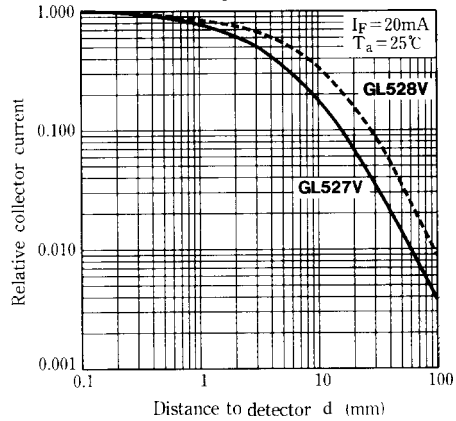

Fig.11-a Radiation Diagram (GL527V)
($T_a = 25^\circ\text{C}$)

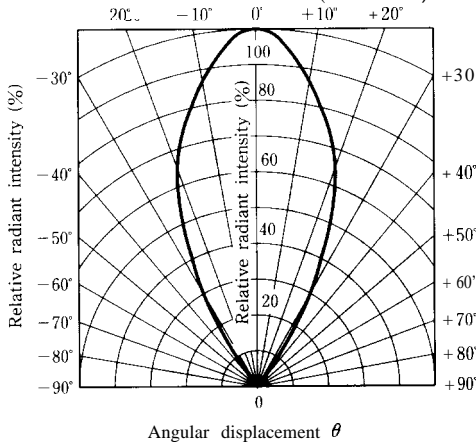
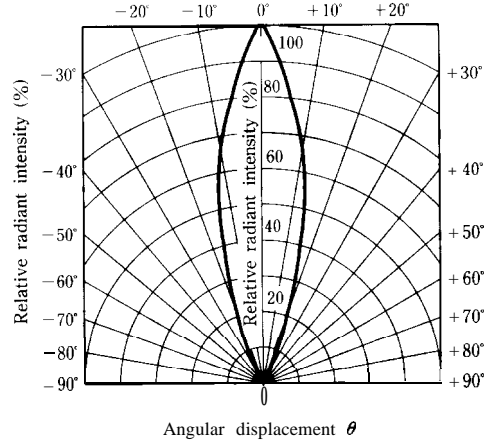

Fig.11-b Radiation Diagram (GL528V)
($T_a = 25^\circ\text{C}$)



Please refer to the chapter "Precautions for Use." (Page 78 to 93)